

# Narrow line width frequency comb source based on an injection-locked III-V-on-silicon mode-locked laser

Sarah Uvin,<sup>1,2,\*</sup> Shahram Keyvaninia,<sup>3</sup> Francois Lelarge,<sup>4</sup> Guang-Hua Duan,<sup>4</sup> Bart Kuyken<sup>1,2</sup> and Gunther Roelkens<sup>1,2</sup>

<sup>1</sup>Photonics Research Group, Department of Information Technology, Ghent University - imec, Sint-Pietersnieuwstraat 41, 9000 Ghent, Belgium

<sup>2</sup>Center for Nano- and Biophotonics (NB-Photonics), Ghent University, Ghent, Belgium

<sup>3</sup>Fraunhofer Heinrich-Hertz-Institut Einsteinufer 37 10587, Berlin, Germany

<sup>4</sup>III-V lab, a joint lab of Alcatel-Lucent Bell Labs France, Thales Research and Technology and CEA Leti, France

\*[sarah.uvin@intec.ugent.be](mailto:sarah.uvin@intec.ugent.be)

**Abstract:** In this paper, we report the optical injection locking of an L-band ( $\sim 1580$  nm) 4.7 GHz III-V-on-silicon mode-locked laser with a narrow line width continuous wave (CW) source. This technique allows us to reduce the MHz optical line width of the mode-locked laser longitudinal modes down to the line width of the source used for injection locking, 50 kHz. We show that more than 50 laser lines generated by the mode-locked laser are coherent with the narrow line width CW source. Two locking techniques are explored. In a first approach a hybrid mode-locked laser is injection-locked with a CW source. In a second approach, light from a modulated CW source is injected in a passively mode-locked laser cavity. The realization of such a frequency comb on a chip enables transceivers for high spectral efficiency optical communication.

© 2016 Optical Society of America

**OCIS codes:** (250.5300) Photonic integrated circuits; (140.4050) Mode-locked lasers.

---

## References and links

1. D. Hillerkuss, R. Schmogrow, T. Schellinger, M. Jordan, M. Winter, G. Huber, T. Vallaitis, R. Bonk, P. Kleinow, F. Frey, M. Roeger, S. Koenig, A. Ludwig, A. Marculescu, J. Li, M. Hoh, M. Dreschmann, J. Meyer, S. Ben Ezra, N. Narkiss, B. Nebendahl, F. Parmigiani, P. Petropoulos, B. Resan, A. Oehler, K. Weingarten, T. Ellermeier, J. Lutz, M. Moeller, M. Huebner, J. Becker, C. Koos, W. Freude, and J. Leuthold, "26 Tbit s<sup>-1</sup> line-rate super-channel transmission utilizing all-optical fast Fourier transform processing," *Nat. Photonics* **5**, 364–371 (2011).
2. B. R. Washburn, S. A. Diddams, N. R. Newbury, J.W. Nicholson, M. F. Yan, and C. G. Jrgensen, "Phase-locked, erbium-fiber-laser-based frequency comb in the near infrared," *Opt. Lett.* **29**, 250–252 (2004).
3. M. Seimetz, "Laser linewidth limitations for optical systems with high-order modulation employing feed forward digital carrier phase estimation," in *Optical Fiber Communication Conference/National Fiber Optic Engineers Conference*, OSA Technical Digest (CD) (Optical Society of America, 2008), paper OTuM2.
4. J. Pfeifle, V. Brasch, M. Laueremann, Y. Yu, D. Wegner, T. Herr, K. Hartinger, P. Schindler, J. Li, D. Hillerkuss, R. Schmogrow, C. Weimann, R. Holzwarth, W. Freude, J. Leuthold, T. Kippenberg, and C. Koos, "Coherent terabit communications with microresonator Kerr frequency combs," *Nat. Photonics* **8**, 375–380 (2014).
5. I. Morohashi, T. Sakamoto, H. Sotobayashi, T. Kawanishi, I. Hosako, and M. Tsuchiya, "Widely repetition-tunable 200 fs pulse source using a Mach-Zehnder-modulator-based flat comb generator and dispersion-flattened dispersion-decreasing fiber," *Opt. Lett.* **33**, 1192–1194 (2008).
6. A. Ishizawa, T. Nishikawa, A. Mizutori, H. Takara, A. Takada, T. Sogawa, and M. Koga, "Phase-noise characteristics of a 25-GHz-spaced optical frequency comb based on a phase-and intensity-modulated laser," *Opt. Express* **21**, 29186–29194 (2013).

7. B. R. Koch, A. W. Fang, E. Lively, R. Jones, O. Cohen, D. J. Blumenthal, and J. E. Bowers, "Mode locked and distributed feedback silicon evanescent lasers," *Laser Photonics Rev.* **3**, 355–369 (2008).
8. S. Srinivasan, M. Davenport, M. J. Heck, J. Hutchinson, E. Norberg, G. Fish, and J. E. Bowers, "Low phase noise hybrid silicon mode-locked lasers," *Front. Optoelectron.* **7**, 265–276 (2014).
9. S. Keyvaninia, S. Uvin, M. Tassaert, X. Fu, S. Latkowski, J. Mariën, L. Thomassen, F. Lelarge, G. Duan, P. Verheyen, G. Lepage, J. Van Campenhout, E. Bente, and G. Roelkens, "Narrow-linewidth short-pulse III-V-on-silicon mode-locked lasers based on a linear and ring cavity geometry," *Opt. Express* **23**, 3221–3229 (2015).
10. S. Keyvaninia, S. Uvin, M. Tassaert, Z. Wang, X. Fu, S. Latkowski, J. Mariën, L. Thomassen, F. Lelarge, G. Duan, G. Lepage, P. Verheyen, J. Van Campenhout, E. Bente, and G. Roelkens, "III-V-on-silicon anti-colliding pulse-type mode-locked laser," *Opt. Lett.* **40**, 3057–3060 (2015).
11. E. Sooudi, S. Sygletos, A. D. Ellis, G. Huyet, J. G. McInerney, F. Lelarge, K. Merghem, R. Rosales, A. Martinez, A. Ramdane, and S. Hegarty, "Optical frequency comb generation using dual-mode injection-locking of quantum-dash mode-locked lasers: Properties and applications," *IEEE J. Quantum Electron.* **48**, 1327–1338 (2012).
12. Y. Cheng, X. Luo, J. Song, T.-Y. Liow, G.-Q. Lo, Y. Cao, X. Hu, X. Li, P. H. Lim, and Q. J. Wang, "Passively mode-locked III-V/silicon laser with continuous-wave optical injection," *Opt. Express* **23**, 6392–6399 (2015).
13. N. Rebrova, T. Habruseva, G. Huyet, and S. P. Hegarty, "Stabilization of a passively mode-locked laser by continuous wave optical injection," *Appl. Phys. Lett.* **97**, 101105 (2010).
14. T. Komljenovic, S. Srinivasan, E. Norberg, M. Davenport, G. Fish, and J. E. Bowers, "Widely-tunable narrow-linewidth monolithically-integrated external-cavity semiconductor lasers," *IEEE J. Sel. Top. Quantum Electron.* **21**, 1501909 (2015).
15. X. Y. Sun, Q. Du, T. Goto, M. C. Onbasli, D. H. Kim, N. M. Aimon, J. Hu, and C. A. Ross, "Single-Step Deposition of Cerium-Substituted Yttrium Iron Garnet for Monolithic On-Chip Optical Isolation," *ACS Photonics* **2**, 856–863 (2015).
16. S. Ghosh, S. Keyvaninia, Y. Shirato, T. Mizumoto, G. Roelkens, and R. Baets, "Optical isolator for TE polarized light realized by adhesive bonding of Ce: YIG on Silicon-on-Insulator waveguide circuits," *IEEE Photon. J.* **5**, 6601108 (2013).

---

## 1. Introduction

The global Internet traffic has grown dramatically in the past two decades. Advanced transceiver technology is indispensable to handle the massive amount of information that needs to be transported over the optical network. The spectral efficiency of these transceivers is of paramount importance for the effective use of the available optical fiber bandwidth. The conventional solution is to use highly parallel wavelength division multiplexing (WDM) with several tens of channels. The spectral efficiency of such a system is however far below the theoretical limit, due to the guard bands inserted in between the wavelength channels. Moreover, the management of large arrays of single wavelength lasers is far from trivial. Coherent optical orthogonal frequency division multiplexing (OFDM) systems can provide a solution to these problems. Tbps optical OFDM communication systems with high spectral efficiency have been demonstrated [1]. Such a system requires an optical frequency comb source to generate an array of narrow line width lines with a fixed phase relation and thus fixed frequency spacing.

The frequency comb can be generated by a mode-locked laser. Because of the mode-locking, the laser lines have inherently a distinct phase relation, while the frequency spacing is determined by the repetition rate of the laser. It has been shown that (stabilized) mode-locked fiber lasers can serve as a frequency comb source, however, these lasers have typically a low repetition rate (and hence too small frequency spacings for optical communication) because of the long laser cavity length [2]. Integrating mode-locked lasers on chip could overcome this problem, and has additionally a clear advantage in volume factor and power consumption. However the line width of the longitudinal modes of such lasers is typically in the MHz-range, which is too broad for advanced coherent communication schemes [3]. To overcome the line width problem Kerr combs have been suggested as alternative. This approach uses the strong Kerr-nonlinearity in integrated microring resonators to generate combs. Although it has been challenging to generate coherent microresonator frequency combs, their wide bandwidth and frequency spacing compared to fiber lasers allow high data rate communication links [4]. However, the relatively low power efficiency in converting the laser light into the sidebands and

high optical pump power needed, hamper the co-integration of the pump laser and resonator on a chip. Alternatively, cascaded phase and amplitude modulation of a narrow line width CW source can be used to create a frequency comb [5, 6]. However, this approach suffers from the high power consumption for driving the modulators and the high insertion loss of the cascade of modulators. We propose a solution based on the injection locking of an integrated mode-locked laser with a narrow line width continuous wave (CW) source. We show that the laser lines generated by the mode-locked laser are coherent with the narrow line width CW source. Due to the low optical power that is needed to lock the mode-locked laser, the system could be completely integrated on a single chip.

Recently, integrated electrically pumped semiconductor mode-locked lasers on silicon photonic integrated circuits were demonstrated [7–10]. The integration of mode-locked lasers on a silicon photonics platform allows using low-loss silicon waveguide structures to form the laser cavity, which positively affects the laser performance. Moreover, high-speed photodetectors and modulators can be co-integrated on the silicon photonics platform, allowing the realization of fully integrated, advanced transceivers. Silicon photonics, leveraging the well-developed CMOS fabrication infrastructure and its economy of scale, provides a distinct cost advantage over other optical technologies for transceiver applications. At the same time it allows lower power consumption and enables the scaling of the aggregate bandwidth of transceivers to the Terabit/s range.

However, to meet the demanding requirements of coherent communications, the mode-locked lasers need to have both a low timing jitter and a narrow optical line width. To improve the timing jitter, hybrid mode-locking can be used to synchronize the repetition rate of the laser to that of an external RF source. The optical line width of the individual lines lies however still in the MHz range, insufficient for coherent communication.

By injection of a narrow line width CW tone in the mode-locked laser, the optical line width can be reduced ideally to the line width of the CW source [11, 12]. In this paper, we report a reduction of the optical laser line width to 50 kHz for a 4.71 GHz repetition rate mode-locked laser. This line width is narrow enough to enable coherent data transmission with advanced modulation formats [3]. Two locking techniques are explored. Both methods address the need for low timing jitter and a narrow optical line width at the same time. In a first approach a hybrid mode-locked III-V-on-silicon laser is injection locked with a CW source. In a second approach, hybrid mode-locking can be avoided, by injecting light from a modulated CW source in the passively mode-locked laser cavity. Coherence between more than 50 longitudinal modes and the CW source is experimentally confirmed.

## 2. Design and fabrication

The injection locking experiments were carried out on a linear cavity colliding pulse III-V-on-silicon mode-locked laser [9]. The device geometry is depicted in Fig. 1. The optical amplifiers and the saturable absorber are implemented in a III-V-on-silicon waveguide section, placed symmetrically in the cavity to obtain colliding pulse operation. The III-V gain section is  $2 \times 430 \mu\text{m}$  long (not including the  $150 \mu\text{m}$  long spotsizer converters), while the III-V saturable absorber is  $100 \mu\text{m}$  long. The confinement factor of the optical mode in the quantum wells is 7.5 % both in the gain section and in the saturable absorber. A  $150 \mu\text{m}$ -long tapered spotsizer converter is used to couple between the hybrid gain section and the passive waveguide section as described in [9]. The main part of the cavity length is formed by two silicon spiral waveguides of each 0.7 cm length in order to reach a pulse repetition rate around 5 GHz (4.71 GHz in the experiment). The cavity mirrors are formed by first order distributed Bragg reflectors (DBR) (255 nm grating period, 50 % duty cycle, 180 nm etch depth), corresponding to a mirror reflectivity around 50 % in the wavelength range of interest. The laser emits in the L-band (around 1580 nm), the

exact wavelength coverage depending on the laser drive conditions. More details on the device fabrication and dimensions can be found in [9].

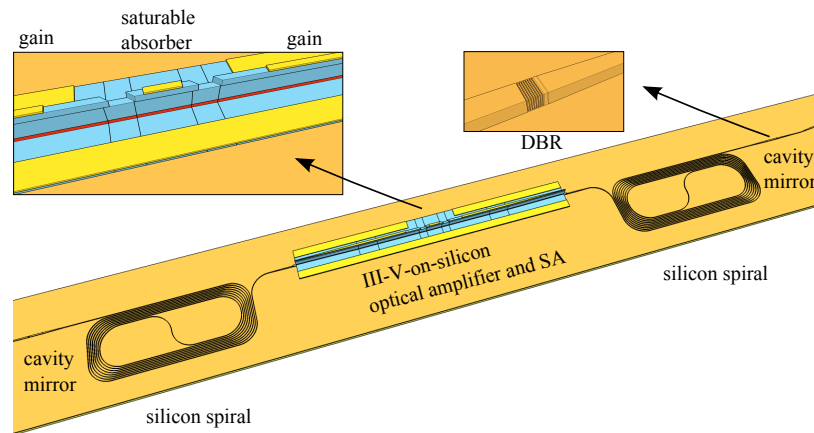

Fig. 1. Illustration of the linear cavity colliding pulse mode-locked laser.

The measurements were carried out with the device on a thermo-electric cooler keeping the device at 20 °C. For the injection locking experiments, the saturable absorber is reverse biased at -1.3 V and 100 mA current is injected in the spotsizer converters and semiconductor optical amplifiers as these settings resulted in the widest injection locking range. For these bias settings, the waveguide coupled laser output power is 6 mW. Although in free-running operation these settings are suboptimal, we noticed that less stable free-running mode-locked operation seems to lead to more stable locking operation under CW injection. This was also reported in [11].

In case of passive mode-locking, the 3 dB optical line width of the longitudinal modes of the mode-locked laser is several MHz and the RF line width was found to be 55 kHz when fitting a Lorentzian curve to the RF spectrum. Hybrid mode-locking and injection locking techniques are therefore needed to meet the stringent requirements of terabits per second coherent communications in terms of line width and phase stability.

### 3. Verifying the coherence of the laser lines spectrally close to the seed laser

Optical injection locking with a narrow line width CW tone has been shown to be an effective technique to reduce the longitudinal modes' phase and frequency noise [12]. By locking the comb generated by the MLL to a narrow line width source, the line width of the longitudinal modes can be reduced, ideally to the line width of the seed.

In a first experiment, a narrow line width fiber-coupled CW source, acting as the seed, is injected in the mode-locked laser through a fiber-to-chip grating coupler. A continuous wave optical parametric oscillator (OPO)-based source with a 50 kHz optical line width was used in the experiment. The wavelength of the narrow line width seed is tuned such that it coincides with the center of the mode-locked laser spectrum. The on-chip CW seed power is 0.6 mW. The position of the longitudinal mode closest to the seed will be pulled toward the seed wavelength, locking both its frequency and phase.

The injection-locking measurement set-up is depicted in Fig. 2. To verify the line width of the comb teeth, a frequency shifted copy of the seed source (by sending it through an acousto-optic modulator (AOM) inducing a 200 MHz frequency shift) is combined with the MLL emission and sent to a high speed photodetector connected to an RF spectrum analyzer recording the beat notes. An optical circulator is used to ensure that only the MLL output beam is combined with

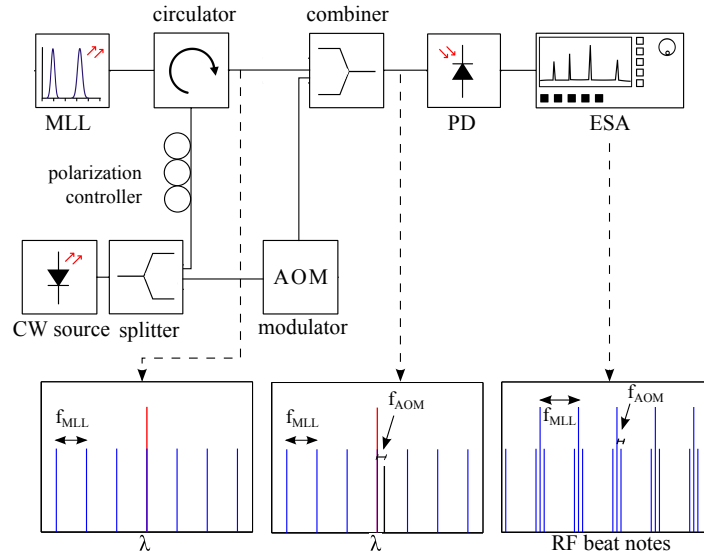

Fig. 2. (a) Measurement set-up to verify the injection locking of the mode-locked laser. The mode-locked laser (blue) is locked to the CW laser (red) (b), combined with a frequency shifted version of the first laser (black) (c) and sent to a photodetector in order to measure the beat notes (d).

the shifted copy of the seed.

With this experiment, we can already verify that the lines with an optical frequency in the vicinity of the seed source are coherent with the seed source. Indeed, the six most adjacent lines to the seed frequency result in a sub-hertz RF beat note when interfered with the frequency shifted seed. This confirms the injection locking and the coherence of these lines. The optical line width of the MLL longitudinal modes is thus reduced down to the line width of the seed source, 50 kHz. Figure 3(a) shows the beat note of the first adjacent line. The 200 MHz shifted copy of the seed will beat with the line, which is spaced by the repetition rate  $f_{\text{MLL}}$  from the original seed source. This leads to beat notes at  $f_{\text{MLL}} - 200\text{MHz}$  and at  $f_{\text{MLL}} + 200\text{MHz}$ , as is shown in Fig. 2. Of course also the repetition rate of the MLL itself is present in the RF spectrum. Figure 3(b) shows a zoom in on the beat note situated around  $f_{\text{MLL}} + 200\text{MHz}$  or 4.909 GHz.

#### 4. Verifying the coherence of the comb source over its whole spectrum

To assess the lines spectrally further away from the seed laser, the measurement set-up depicted in Fig. 4 is used. In this experiment a commercial fiber frequency comb source (Menlo Systems) is used to interfere with the III-V-on-silicon MLL. The commercial frequency comb lines are spaced  $f_{\text{probe}} = 100\text{ MHz}$ . The beat notes of the CW seed source with the commercial fiber comb source have a line width of around 100 kHz. The output of the comb laser is first sent through a filter with a 3 dB bandwidth of 0.1 nm and a tunable center wavelength, such that one can scan over the different lines of the mode-locked laser (spaced 40 pm apart) without probing them all at the same time. Next, the combined output is sent to a photodetector connected to an RF spectrum analyzer to record the beat notes, as indicated in Fig. 4.

Many different beat notes will be generated. With  $f_a$  being the distance between a mode-locked laser longitudinal mode and the nearest neighbour comb line,  $f_{\text{MLL}}$  the repetition rate of the mode-locked laser and  $f_{\text{probe}}$  the repetition rate of probe comb source, we can find beat

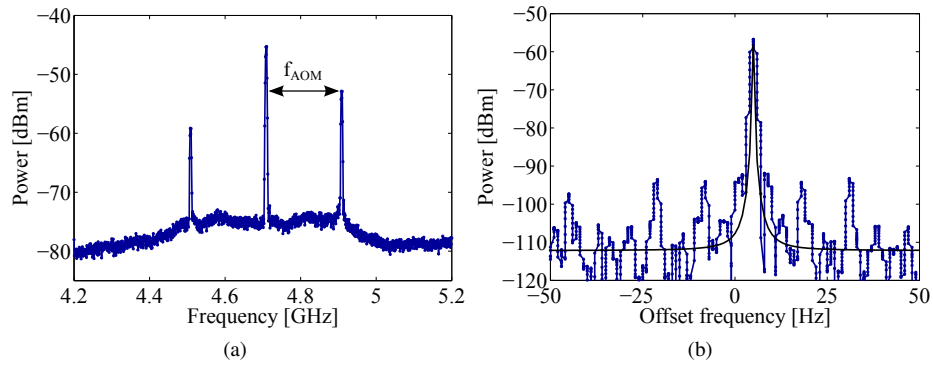

Fig. 3. (a) Lines in the vicinity of the seed are coherent with the seed source (Resolution bandwidth (RBW): 3 MHz), (b) A zoom in on one of the beat notes (situated at 4.909 GHz) shows the beat note has a sub-hertz RF line width (blue: experimental data, black: Lorentzian fit) (RBW: 1 Hz).

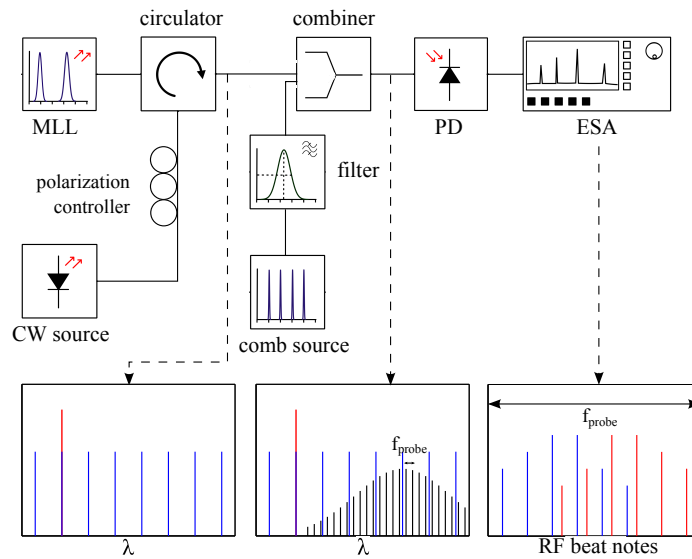

Fig. 4. (a) Measurement set-up to verify the locking of a broad frequency comb. (b) The mode-locked laser (blue) is locked to the CW laser (red). (c) The output signal is combined with a filtered commercial comb laser (black) with a comb line spacing of  $f_{probe} = 100$  MHz. (d) The beat notes are recorded on an electrical spectrum analyzer.

notes at:

$$\pm f_a + m f_{\text{MLL}} + l f_{\text{probe}} \quad m, l \in \mathbb{Z} \quad (1)$$

the line width of which is determined by the line width of the MLL longitudinal modes and that of the reference comb source. To minimize both the line width of the longitudinal modes of the MLL (measure of the stability of the total comb position) and the RF line width (measure of the stability of the repetition rate), two approaches are considered. In a first approach, the MLL is first hybrid mode-locked with an external RF source and then injection-locked to a

narrow seed laser. In a second approach, a passively mode-locked laser is injection-locked to a modulated narrow seed laser.

#### 4.1. Injection locking of a hybrid mode-locked laser with a CW source.

Hybrid mode-locking was obtained by delivering a local oscillator signal at 4.71 GHz (5 dBm RF power at the RF generator) to the saturable absorber using a bias-T. This results in a sub-hertz RF line width of the repetition rate, but the optical line width of the individual lines did not improve compared to passive mode-locking. In order to reduce the optical line width, the hybrid mode-locking needs to be combined with optical injection locking with a narrow line width seed laser.

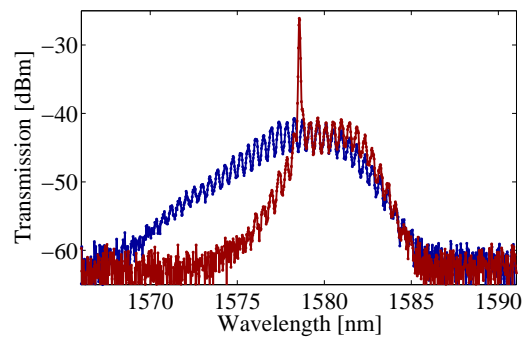

Fig. 5. Optical spectrum of the mode-locked laser without injection locking (blue) and with injection locking ( $P_{CW} = 0.6$  mW in the waveguide)(red) (60 pm spectral resolution).

In Fig. 5, the optical spectrum before (blue) and after (red) injection locking is depicted. The injection power was measured to be 0.6 mW on chip. The optical spectrum becomes narrower compared to the non-injection locked state. This has been reported both in [11] and [12]. Before injection locking a 6.5 nm 3 dB optical bandwidth was measured. When the mode-locked laser is injection locked to the seed, a red shift of the spectrum occurs and the optical bandwidth reduces, as also discussed in [13].

In Fig. 6, the beat notes of the mode-locked laser longitudinal modes with the filtered probe comb lines are plotted. The center of the filter was positioned at 1579.2 nm. We can distinguish 12 different lines that correspond to the aforementioned equation 1 (the peak around 50 MHz actually corresponds to 2 lines very close together, as is shown in Fig. 6(b)). Line 1a and 1b result from two fiber frequency comb lines spaced  $f_a$  and  $f_{probe} - f_a$  from the same MLL comb line. Line 2a and 2b result from the beating of the probe comb with the neighbouring MLL comb line and so on, meaning 6 mode-locked laser longitudinal modes are probed. From the Lorentzian fit of any of the beat notes, a beat note 3 dB line width  $< 100$  kHz is obtained, which is the limit of the measurement system. This proves that the probed mode-locked laser lines are coherent with the seed source.

To determine the total number of comb lines that is coherent with the seed, the probe comb is swept over the different mode-locked laser lines by tuning the center of the filter. Narrow beat notes can be measured from a center wavelength of 1578.4 nm to 1579.5 nm for an injection power of 0.6 mW on chip, indicating that 30 mode-locked laser lines are coherent with the seed.

When decreasing the optical injection power, the number of coherent lines will decrease. This is illustrated in Fig. 7. However, at excessive optical injection ( $\sim 1$  mW) single mode CW operation is obtained (at the injection wavelength).

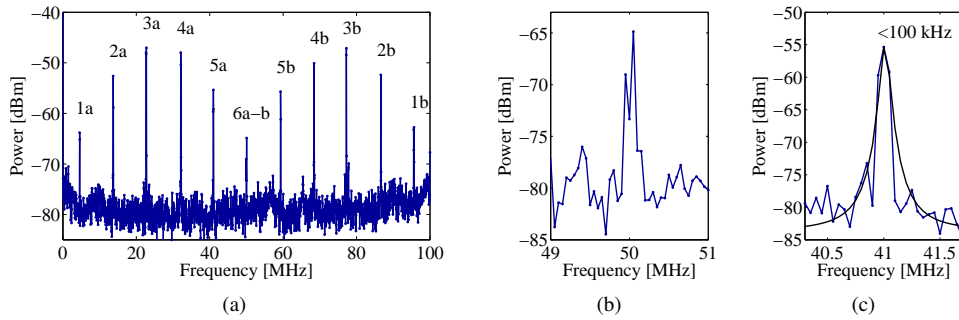

Fig. 6. (a) Beat notes recorded on the electrical spectrum analyzer, (b) Zoom in on peak 6a and b, (c) Lorentzian fit of one of the beat notes with a 3 dB line width < 100 kHz (blue: experimental data, black: Lorentzian fit) (RBW: 50 kHz).

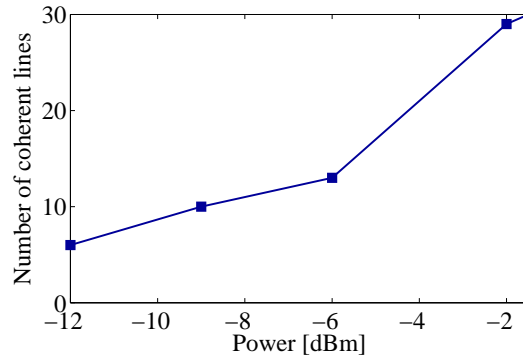

Fig. 7. Number of coherent mode-locked laser lines as a function of CW seed power in the waveguide.

#### 4.2. Injection locking of a passively mode-locked laser with a modulated CW laser.

In a second approach, hybrid mode-locking can be avoided without losing control over the repetition rate of the MLL. This can be achieved by modulation of the narrow line width seed at the repetition rate of the mode-locked laser. Optical injection locking of the MLL with a modulated seed narrows both the line width of the longitudinal modes and the RF beat notes.

Figure 8 shows the fundamental RF tone of the free running passive mode-locking (Fig. 8(a)), optical injection locking with a CW seed (passive mode-locking) (Fig. 8(b)) and optical injection locking with a modulated seed (passive mode-locking) (Fig. 8(c)). We can see that CW optical injection locking of the passive MLL already reduces the 3 dB line width from 55 kHz to 40 kHz. Using a modulated seed results in a sub-hertz 3 dB RF line width (Fig. 8(c)). A seed modulation depth of 11 dB was used in the experiment. In Fig. 8(c) side peaks can be observed more than 50 dB below the fundamental RF tone. The origin of these side peaks is not well understood.

The beat notes of the mode-locked laser with the filtered probe comb are depicted in Fig. 9. The CW injection power is 0.1 mW on chip and the center of the filter was positioned at 1579.4 nm. Similar as in Fig. 6(a), we can distinguish 12 different beat notes. Line 1a and 1b result from two fiber frequency comb lines spaced  $f_a$  and  $f_{\text{probe}} - f_a$  from the same MLL comb



line. Line 2a and 2b result from the beating of the probe comb with the neighbouring MLL comb line and so on, meaning 6 mode-locked laser longitudinal modes are probed. Similar to the previous experiments, line widths  $< 100$  kHz are obtained from the Lorentzian fit, proving that the probed mode-locked laser lines are coherent with the seed laser.

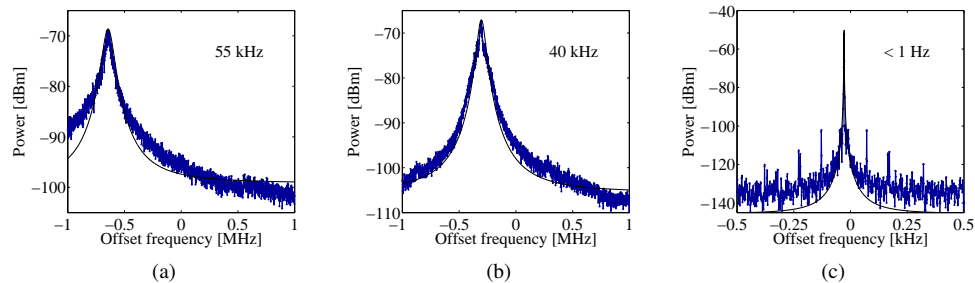

Fig. 8. Modulation of the seed laser narrows the RF line width. Plot of the fundamental tone at 4.71 GHz under different locking conditions: (a) passive MLL without optical injection (RBW: 3 kHz), (b) passive MLL with optical injection (RBW: 3 kHz), (c) passive MLL with modulated injection (RBW: 1 Hz). Measurement data (red), Lorentzian fit (black). The measured 3 dB line width is indicated on all three graphs.

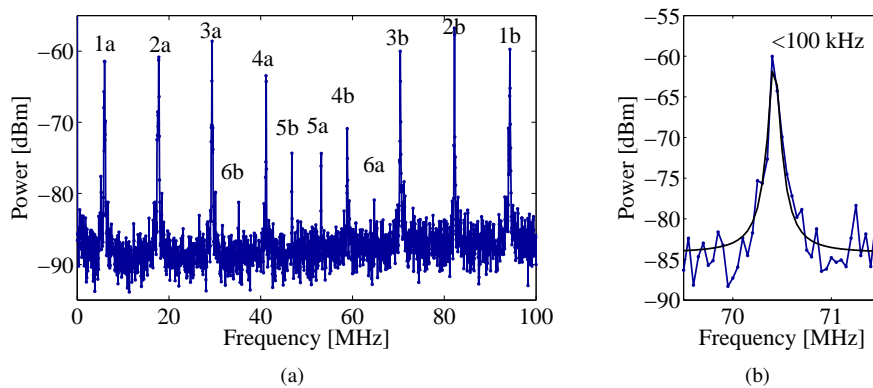

Fig. 9. (a) Beat notes recorded at the electrical spectrum analyzer, (b) Lorentzian fit of one of the beat notes with a 3 dB line width  $< 100$  kHz (blue: experimental data, black: Lorentzian fit) (RBW: 50 kHz).

When sweeping the probe comb over the different mode-locked laser lines, narrow beat notes can be measured from a center wavelength of 1578.3 nm to 1580.4 nm for an injection power of 0.1 mW on chip, indicating that 55 mode-locked laser lines are coherent with the seed laser. The beat notes measured at different center wavelengths are shown in Fig. 10. The positions of all measured beat notes correspond with equation 1 and can be understood in the same way as Fig. 9(a), which is the same as Fig. 10(c).

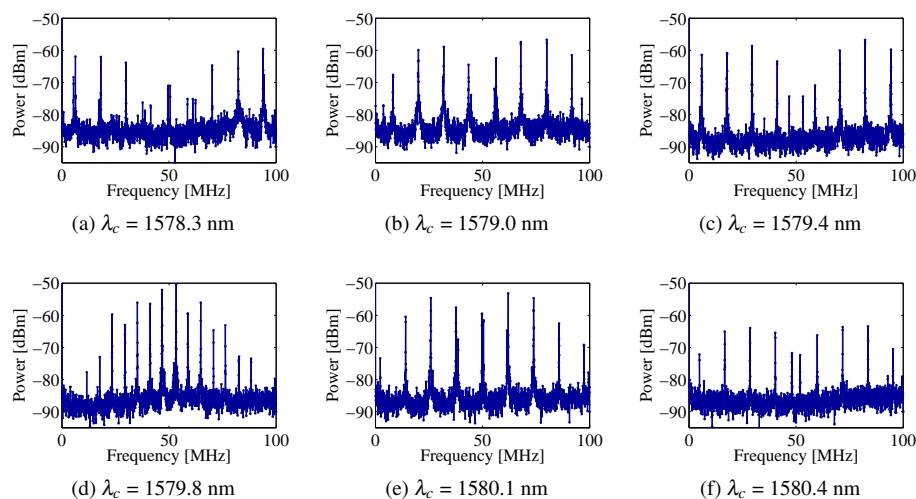

Fig. 10. Beat notes recorded on the electrical spectrum analyzer when sweeping the probe comb over the different mode-locked laser lines. The center wavelength  $\lambda_c$  of the filter is indicated for each graph. (RBW: 50 kHz)

## 5. Conclusion

In summary, we have demonstrated that injection locked III-V-on-silicon mode-locked lasers can operate as coherent comb sources. It was shown that under optical injection locking the 3 dB optical line width is reduced from a  $\sim$ MHz line width to a 50 kHz line width. With a CW injection power as low as 0.1 mW, coherence between more than 50 mode-locked laser modes and the CW laser is experimentally confirmed. Such sources can be used for advanced optical transceivers, but also in other applications, such as microwave photonics and on-chip dual comb spectroscopy. While in this paper the seed laser was external to the MLL chip, recently ultra-narrow line width (50 kHz) III-V-on-silicon tunable lasers were demonstrated [14], as well as on-chip optical isolators [15, 16], enabling the monolithic integration of such a frequency comb source.

## Acknowledgment

Sarah Uvin thanks the Agency for Innovation by Science and Technology in Flanders (IWT) for a PhD grant. We thank Dr. Nathalie Picque for fruitful discussions and the use of the fiber based frequency comb. This work was partly carried out in the framework of the European Space Agency Electro-Photonic Frequency Converter project.