

Silicon Photonics

Dries Van Thourhout
OFC 2010 - Tutorial

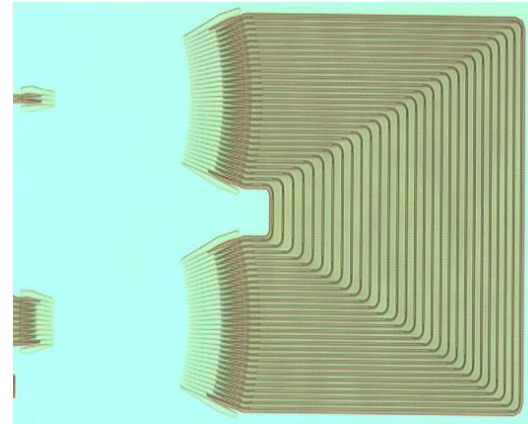
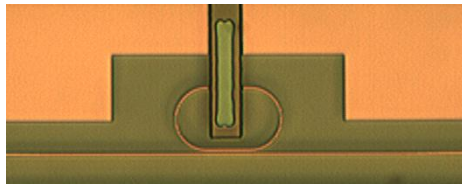
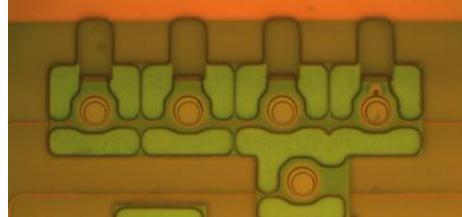

Presentation will be available from <http://photonics.intec.ugent.be/download>

Silicon Photonics

Dries Van Thourhout
OFC 2010 - Tutorial

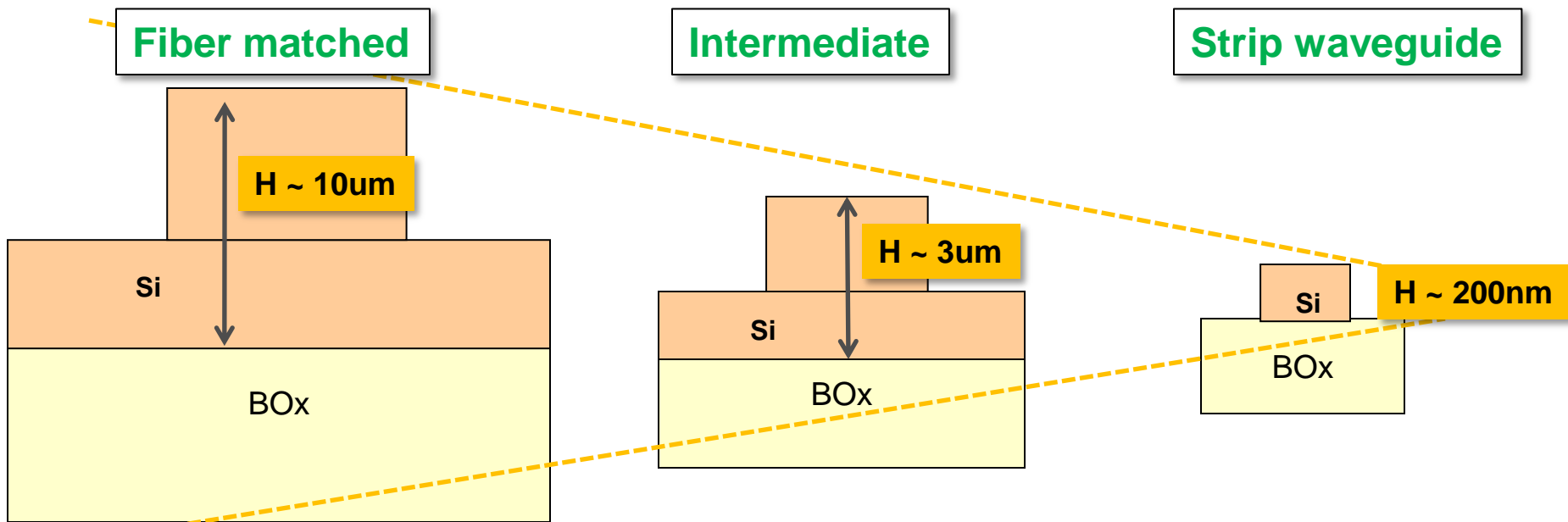

See L. Zimmerman, invited OFC 2010

Silicon Photonics

Dries Van Thourhout
OFC 2010 - Tutorial

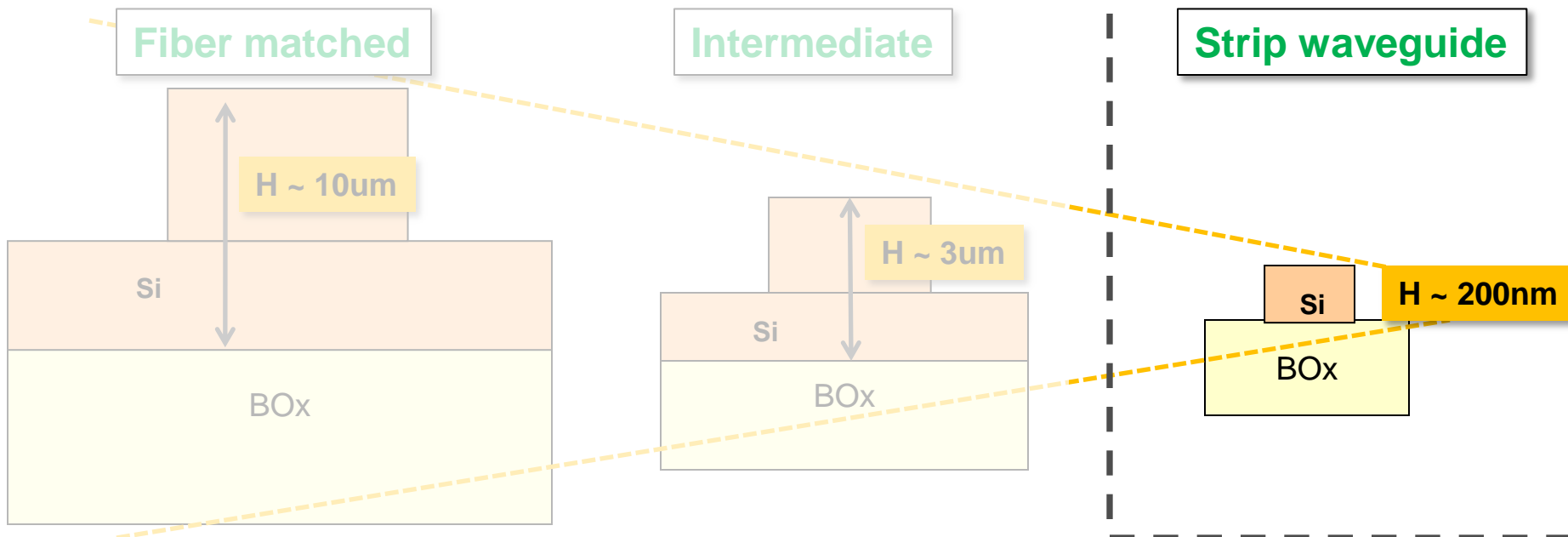

Strip waveguide

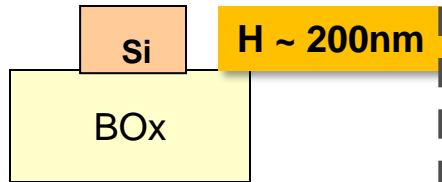

Why Silicon ?

- Silicon is transparent in telecom range
- Processing using very large existing equipment base !!!
- High index contrast → compact circuits
 - But others have sufficient contrast (e.g. SiN, HfO ...)
- Active functionality possible
 - High thermo-optic effect
 - Carrier plasma effect
 - Integration with Germanium, III-V ...

Strip waveguide

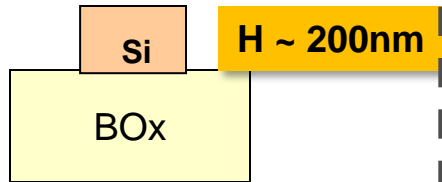

Why strip waveguide ?

- Very compact circuits
- Processing **more** compatible with electronics processing
- Active functionality enhanced
 - Increased light-material interaction
 - Faster devices
 - Lower power consumption
 - Higher non-linear effects

Strip waveguide

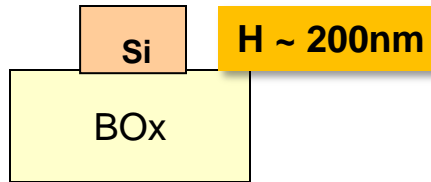

What do we need?

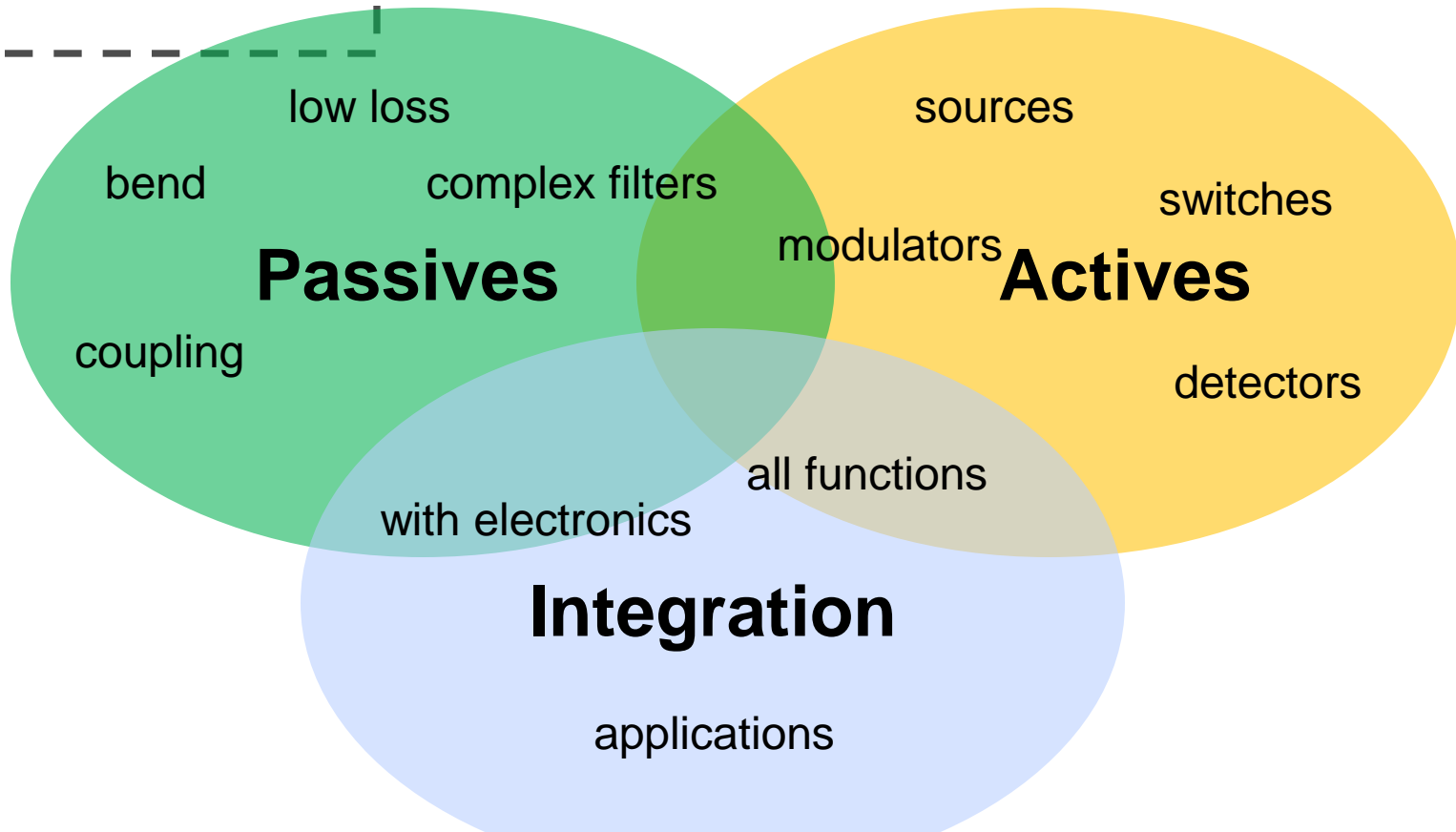

Outline

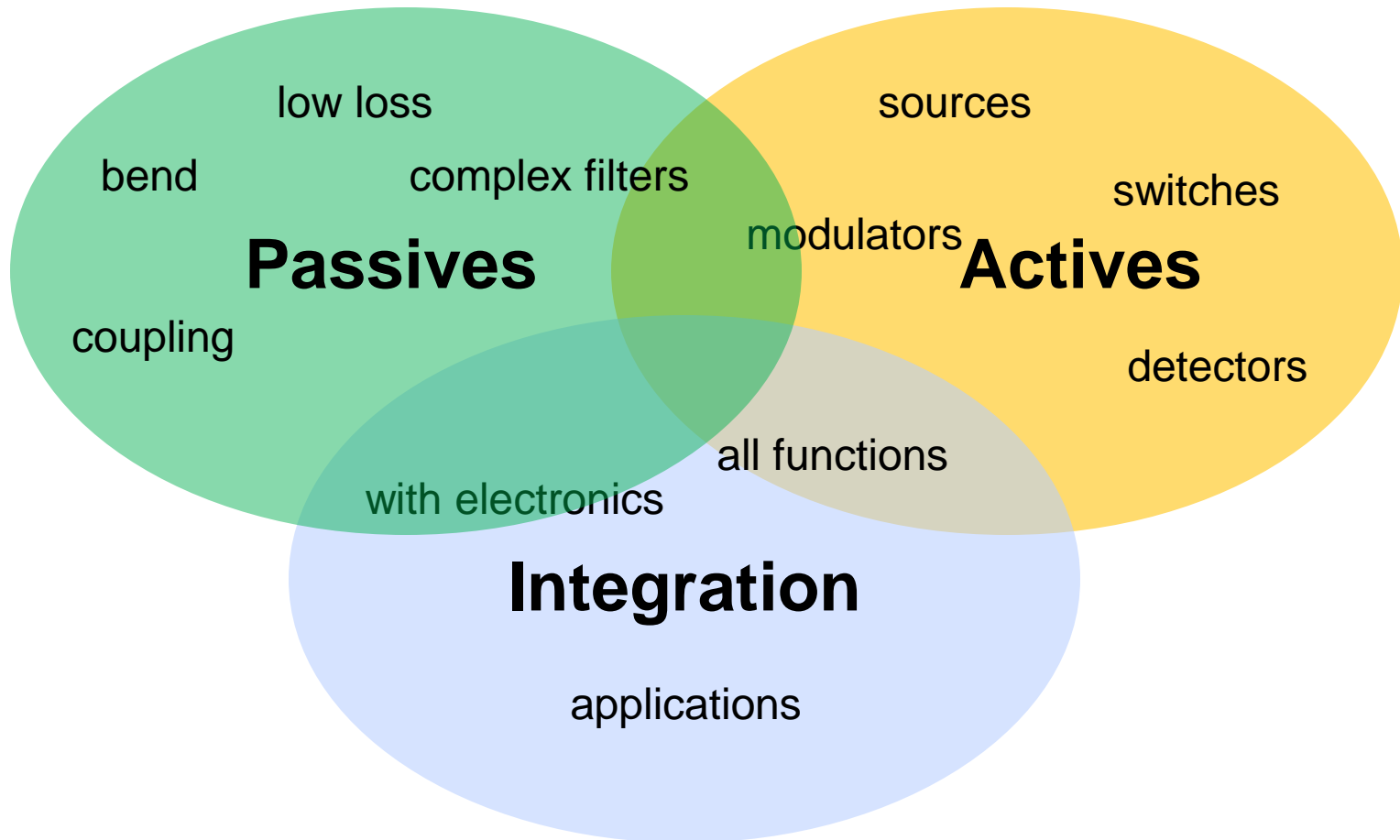

Outline

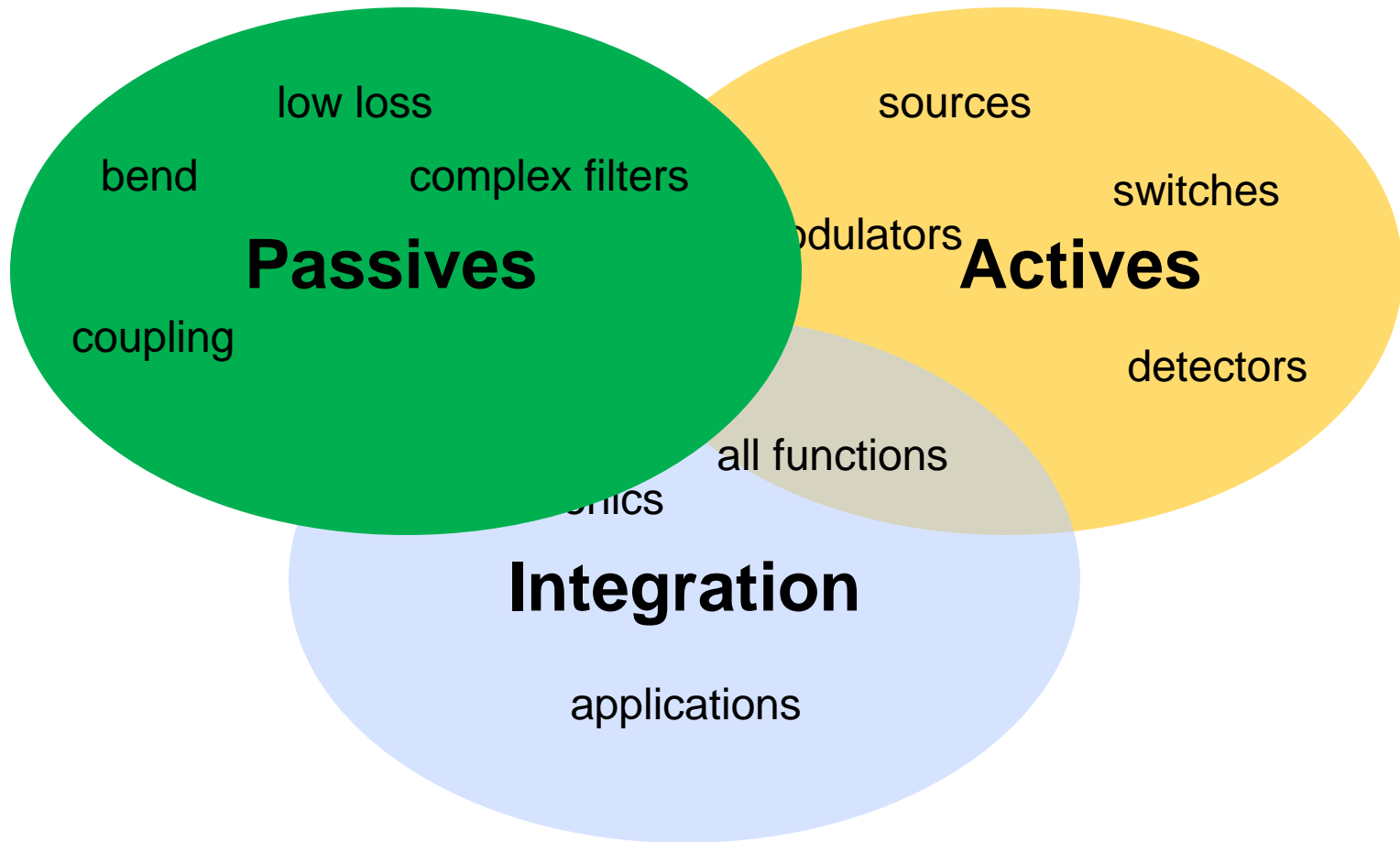

Straight waveguide

Our standard waveguide: 450nm x 220nm Si

- Fabricated using 193nm DUV lithography
- In standard pilot line, on 200mm wafer
- Starting from SOI or amorphous silicon

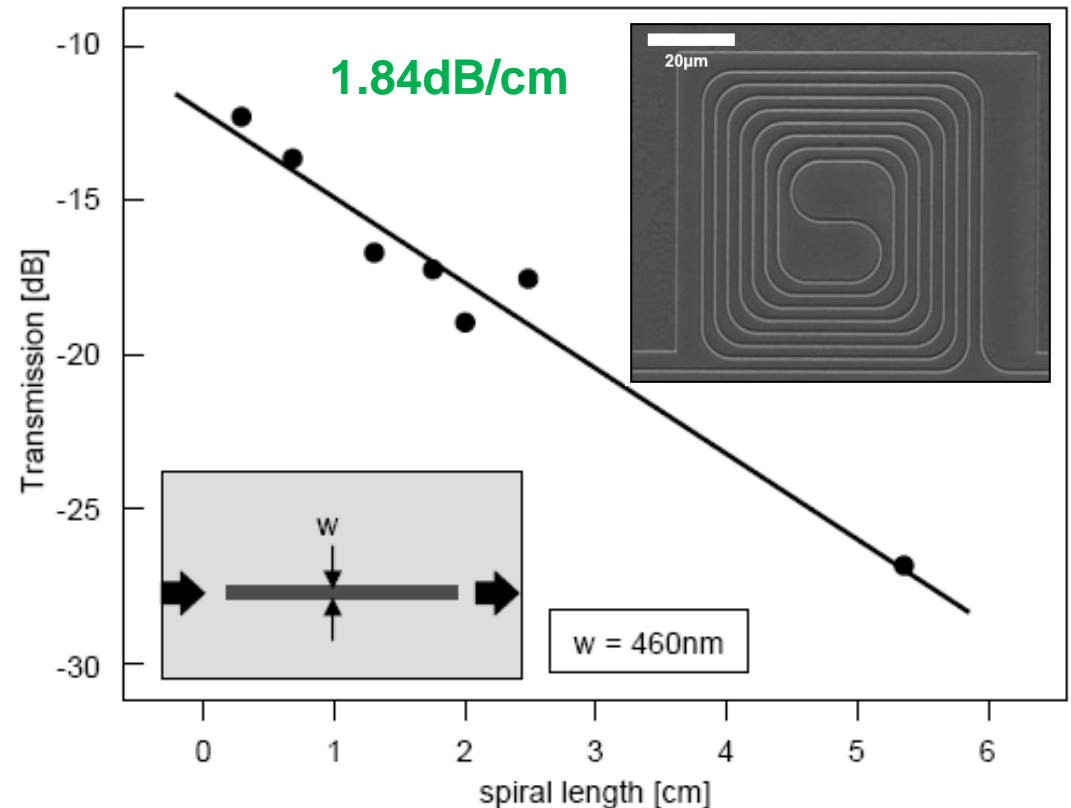
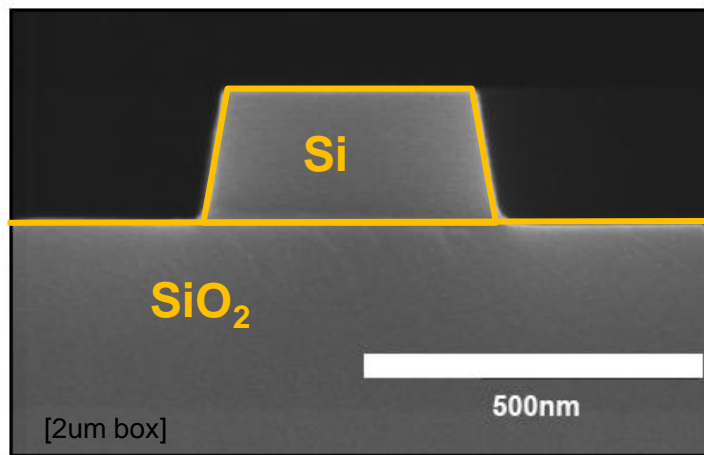

Straight waveguide

Origin of losses ?

- Surface roughness
- Surface absorption

How to decrease losses further ?

- eBEAM lithography + HSQ resist **0.9dB/cm**
- Surface treatment
 - Wet or dry oxidation
 - Hydrogen or other treatment
 - Encapsulation

Gnan e.a., Electronic Lett. 44, p115 (2008)

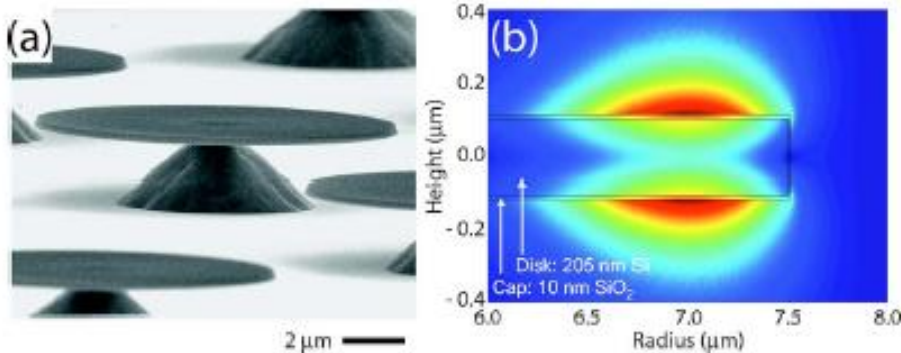

Borselli, Painter, e.a., APL 91, 131117 (2007)

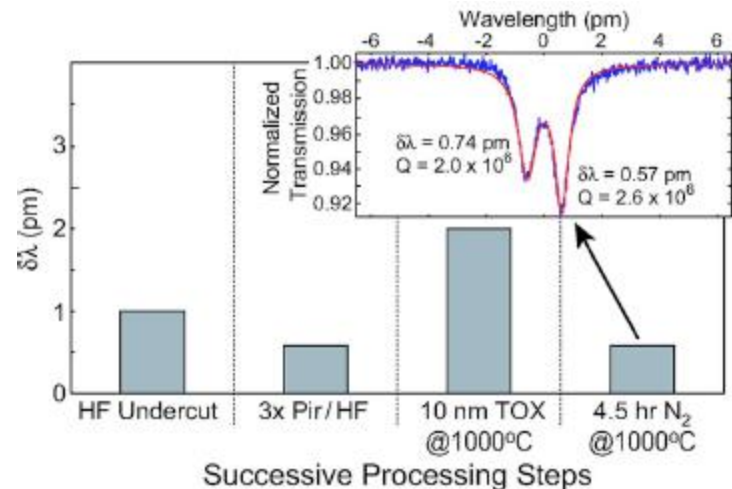

Straight waveguide

Origin of losses

- Surface roughness
- Surface absorption

How to decrease losses further ?

- eBEAM lithography + HSQ resist **0.9dB/cm**
- Surface treatment
 - Wet or dry oxidation
 - Hydrogen or other treatment
 - Encapsulation
- Use wider waveguide
 - Locally multimode waveguide **0.3dB/cm**
 - Include single mode filters
 - (narrow sections or bends)
- Change waveguide shape
 - Optimize confinement at interface

Gnan e.a., Electronic Lett. 44, p115 (2008)

Borselli, Painter, e.a., APL 91, 131117 (2007)

Spector e.a., IPRNA IThE5 (2004)
Toliver e.a., Paper OWJ4

Popovic, PhD Thesis, MIT (2008)

Straight waveguide

Single mode sizes for Si:SiO₂ rectangular waveguide

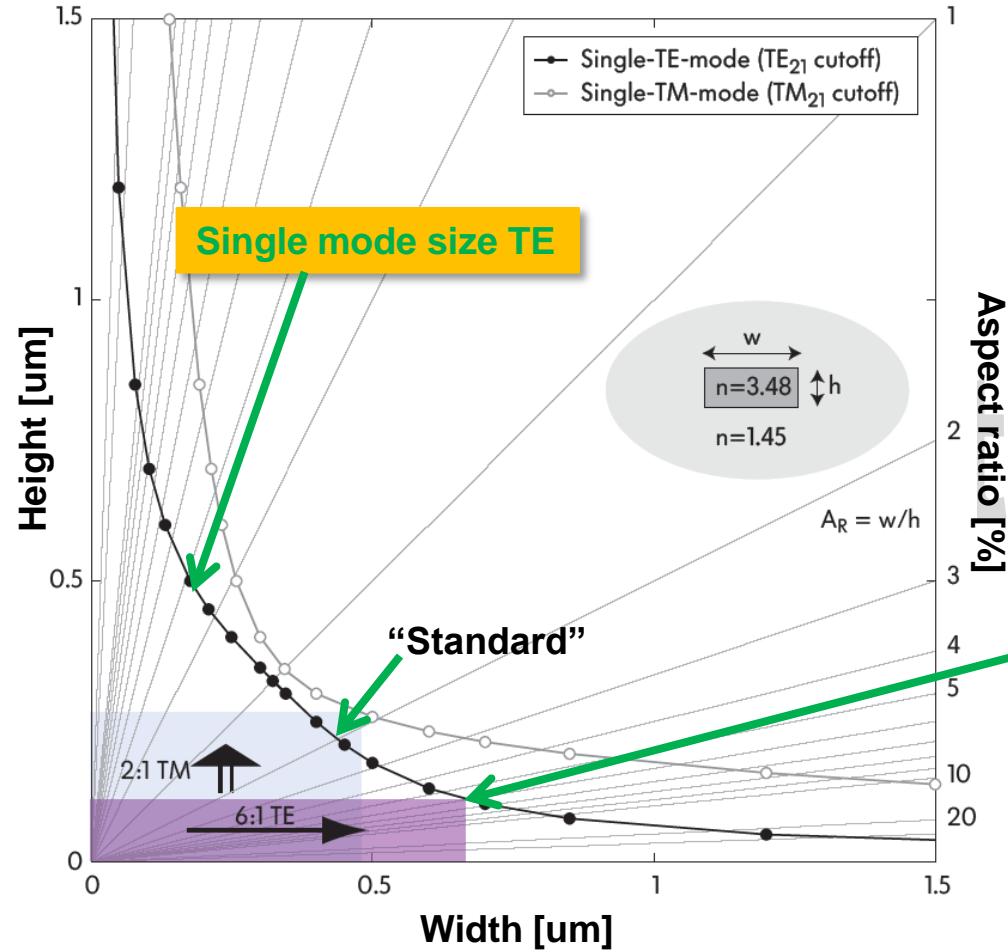

Popovic, PhD Thesis, MIT (2008) (<http://dspace.mit.edu>)

Question:

- Given certain optimization criteria
- What is optimal **aspect ratio** for waveguide ?

Popovic e.a. :

- Optimisation for:
 - Low loss,
 - Low sensitivity to dimensional variations
 - High thermal optic effect
- Choose AR = 6:1 !!!

Alternative optimisation criteria:

- High non-linear effects

Vaillitis, Leuthold, e.a. OE 17 pp. 17357 (2009)

- Optimized sensing (overlap with outside world)

Debackere, PhD thesis UGent (2010)

- Dispersion

Bend waveguide

Our standard waveguide: 450nm x 220nm Si

- Fabricated using 193nm DUV lithography
- In standard pilot line, on 200mm wafer
- Starting from SOI or amorphous silicon

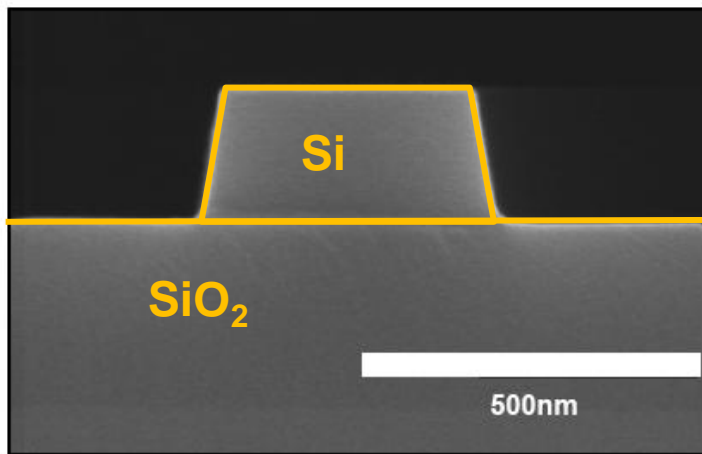

- In agreement with FDTD calculations
- Offset straight-bend might improve (?)

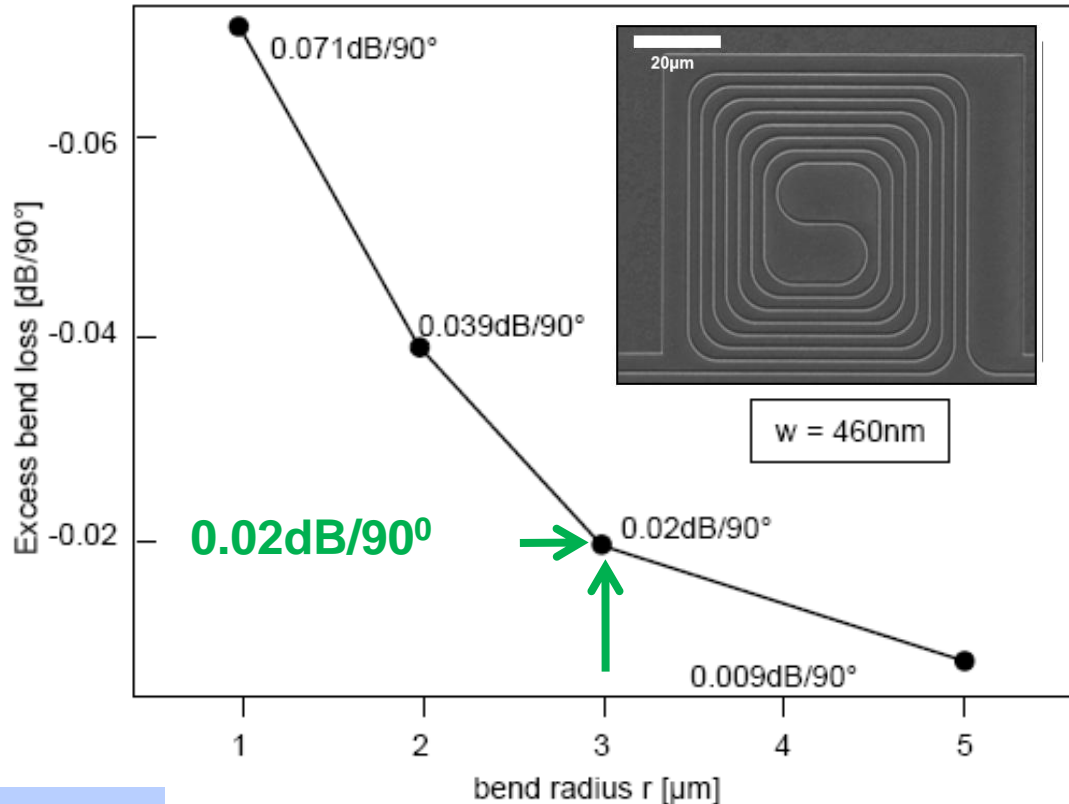

The waveguide bend

FDTD calculations in line with recent experimental results

Bends may introduce unwanted polarization rotation

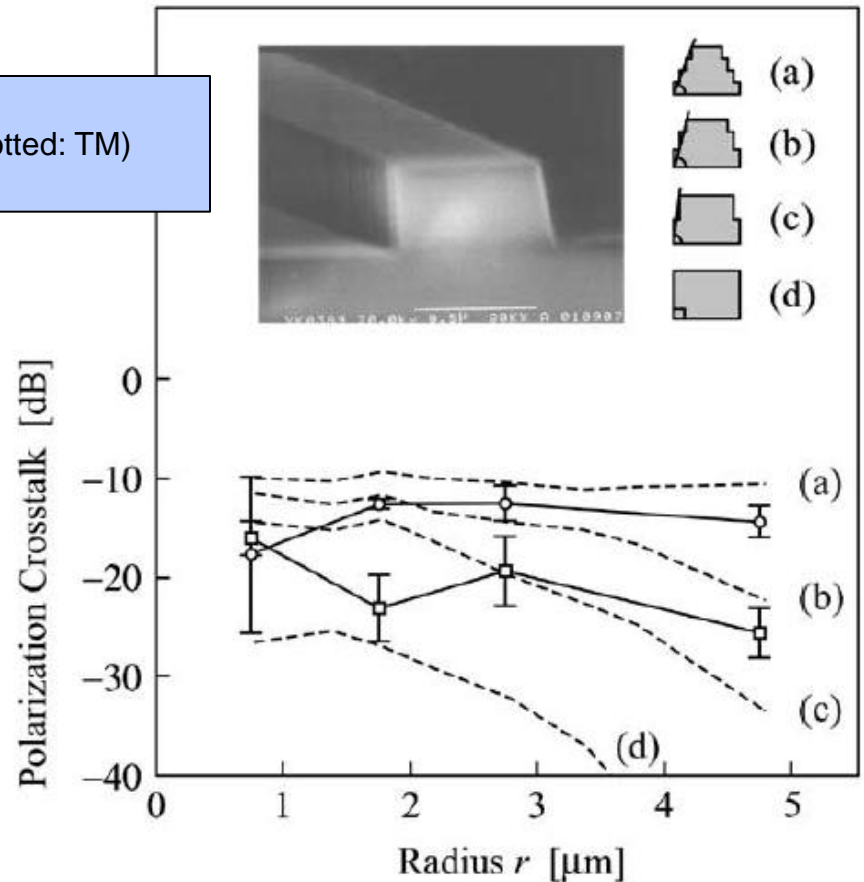
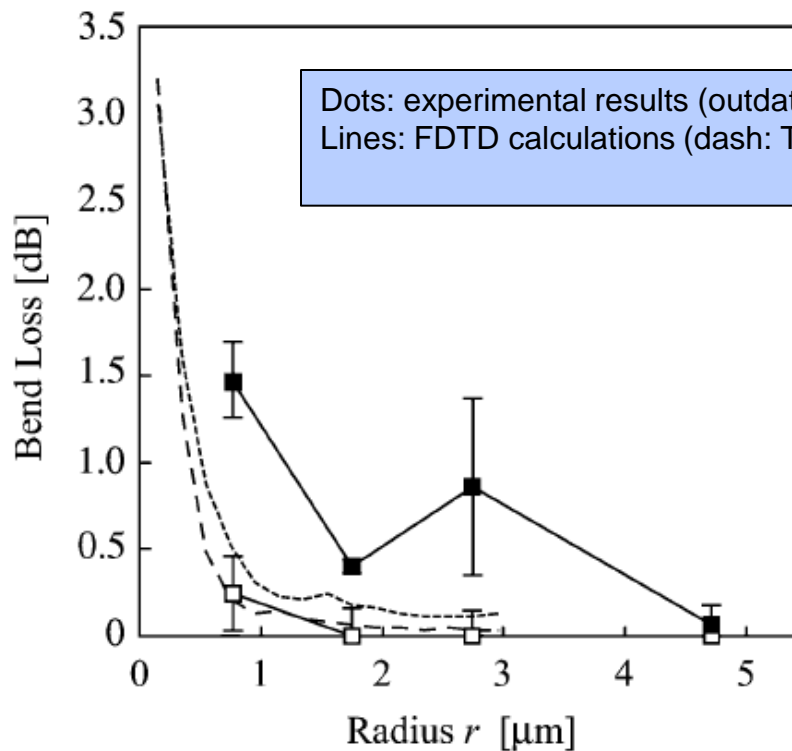

Crossings

Standard Crossing

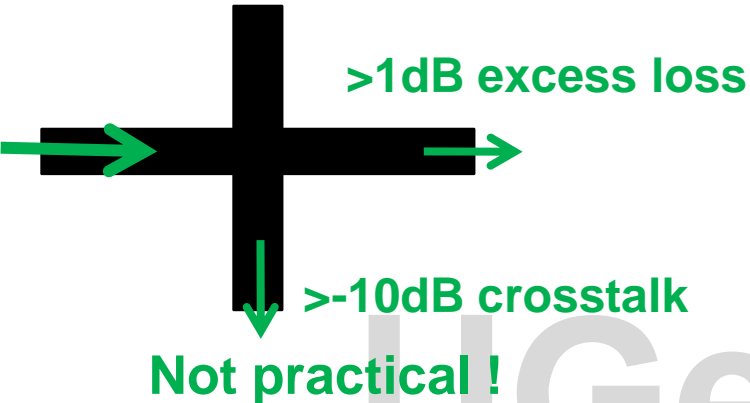

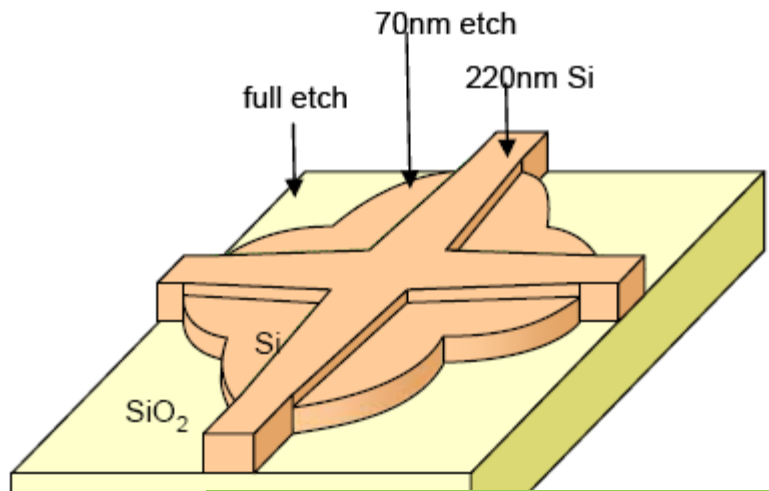

Improved version

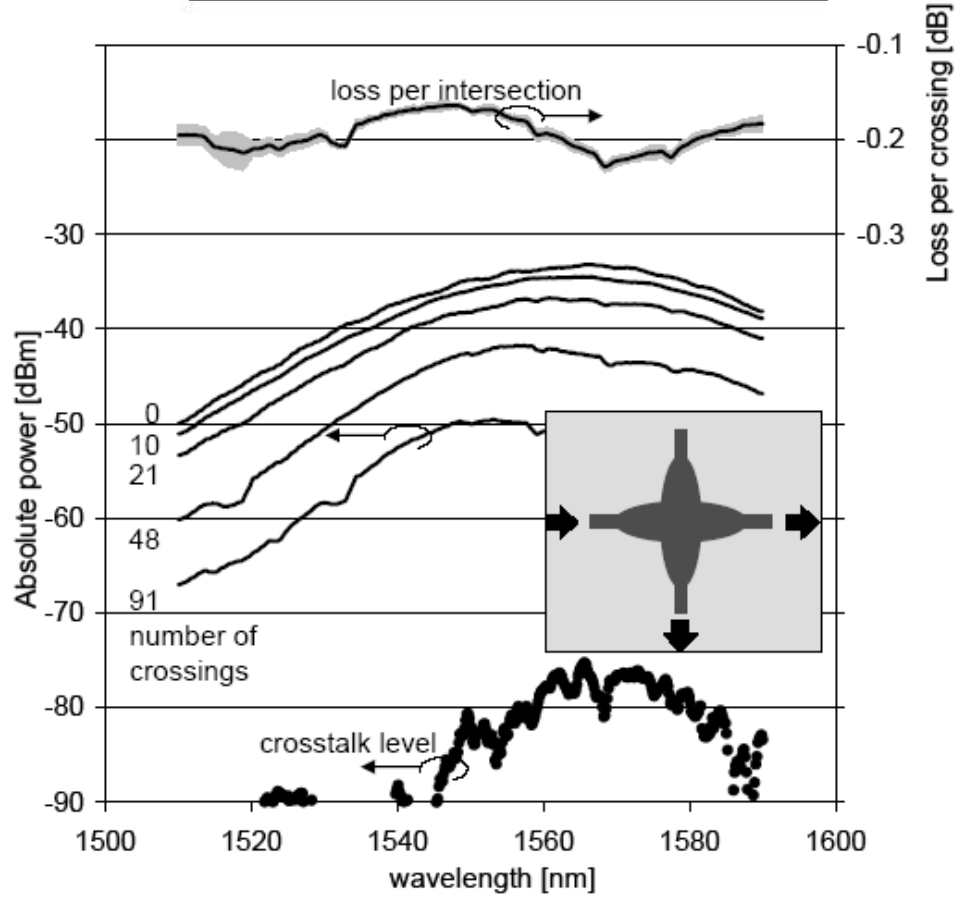
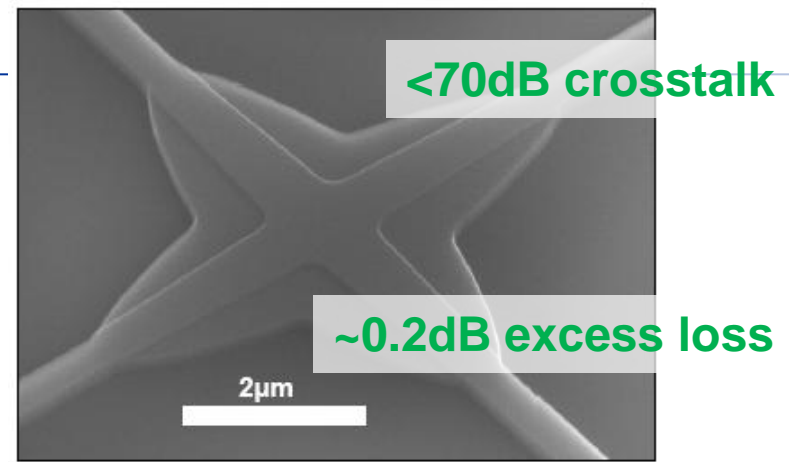

Bogaerts e.a. , JSTQE 16, 33-44 (2010)

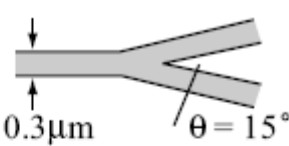
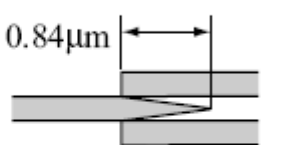
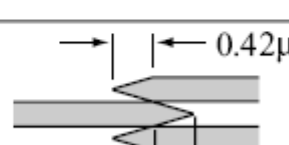
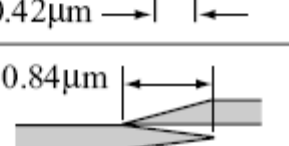
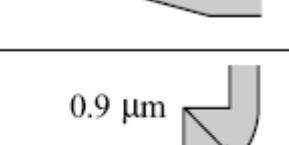

The Y-junction

(a)		2.0 dB
(b)		0.5 dB
(c)		0.5 dB
(d)		< 0.1 dB
(e)		0.3 dB
(f)		< 0.1 dB

Large **losses** for standard Y-junction
Need **improved** design !!!

Example

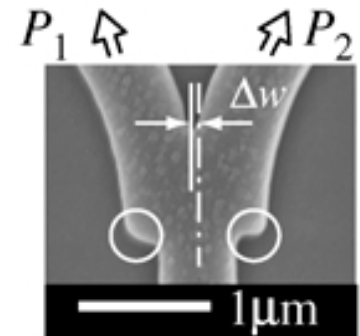
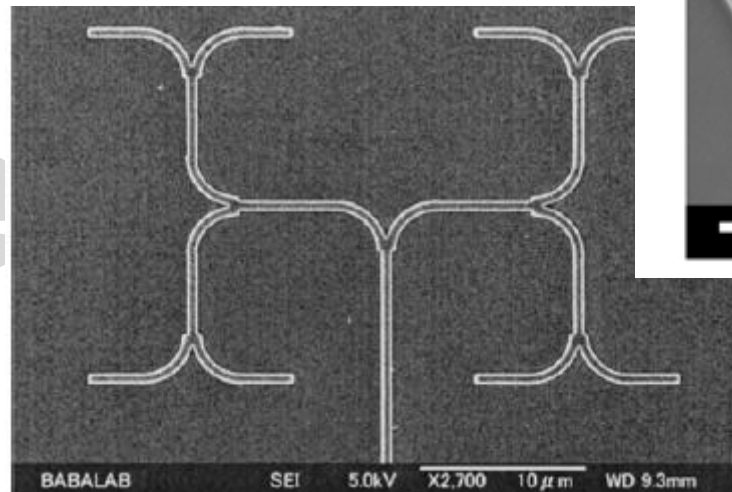

Simulation: <0.1dB excess loss

- Experiment: 0.3dB excess loss
- Some imbalance due to opt. Prox.

The Y-junction

Use Y-junctions to fabricate TO-switches

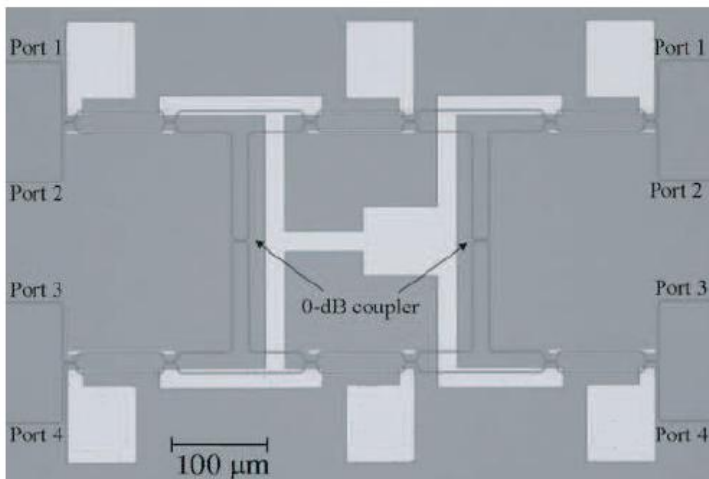
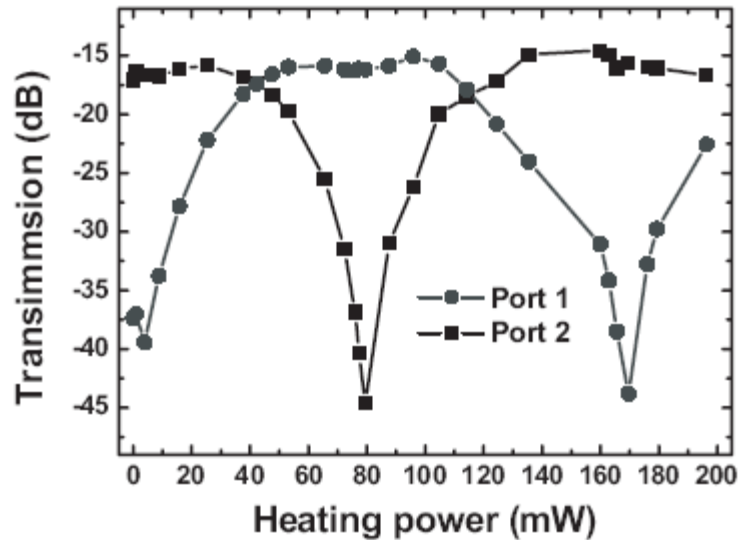
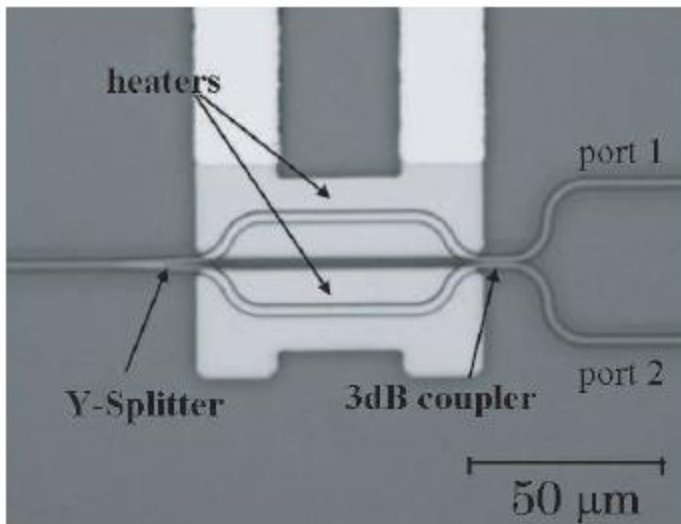

4 x 4 switch

Yamada e.a., PIERS proc., Beijing, p. 22 (2009)

Passive guiding structures

Standard MMI splitter

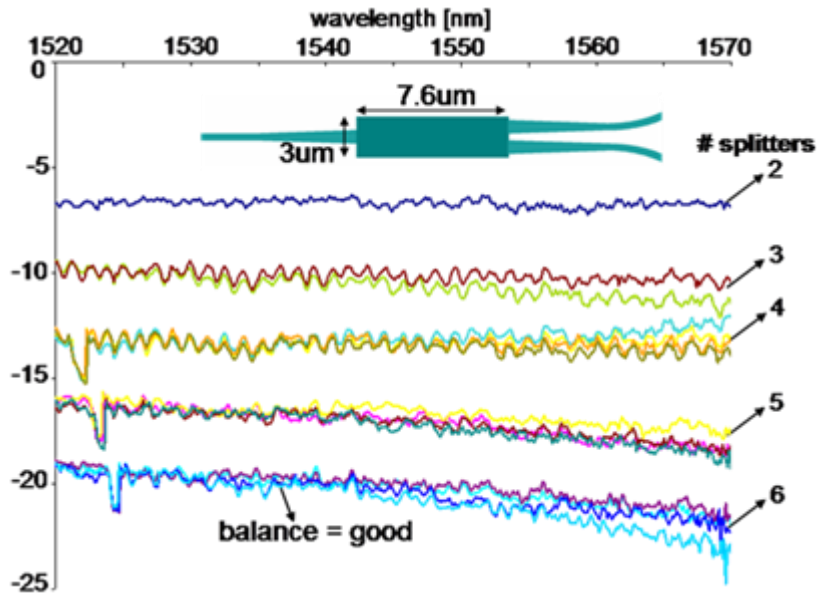

→ 0.3dB excess loss

Improved version

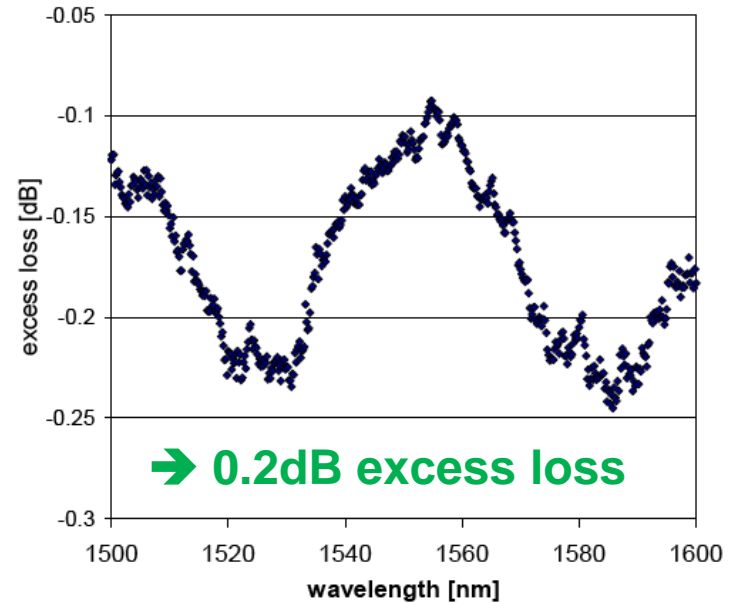
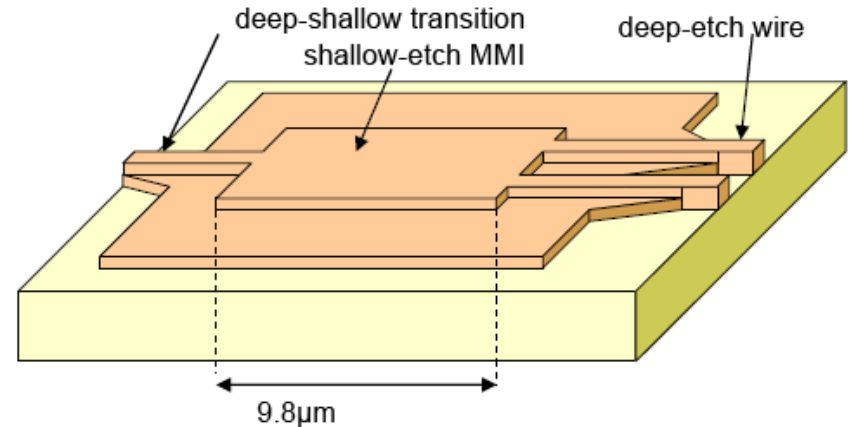

→ 0.2dB excess loss

Arrayed waveguide grating routers

Original devices

Compact, but ...

- High loss (8dB)
- High crosstalk (only 7dB down)

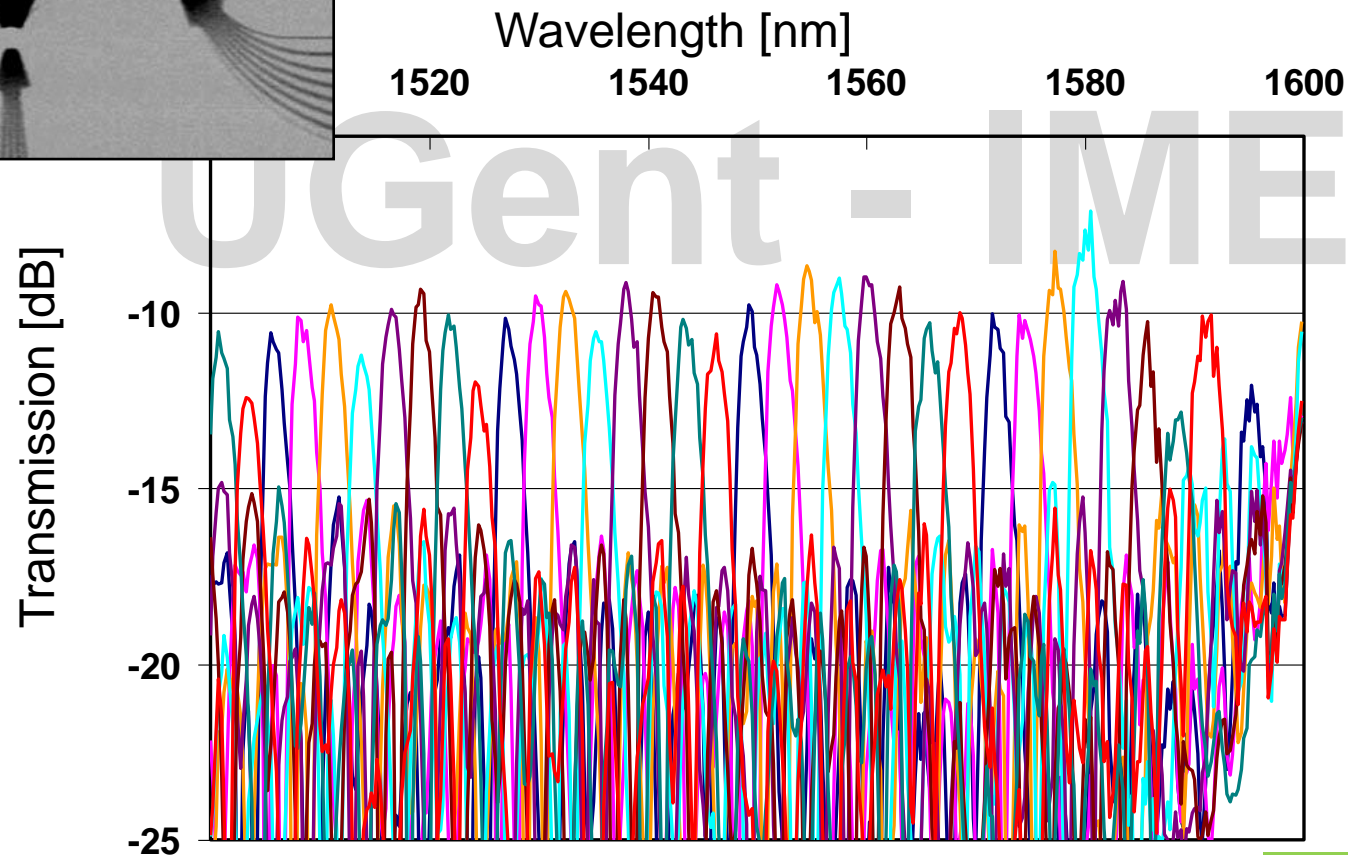
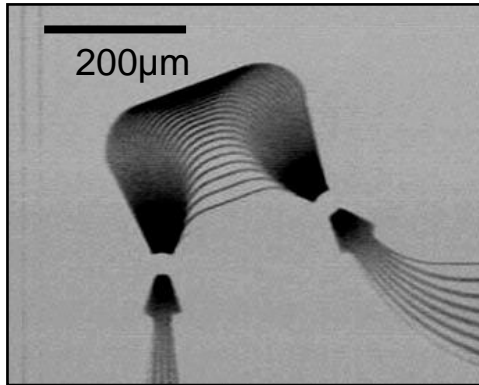

Arrayed Waveguide Grating

8-channel, 400GHz

FSR = 30nm

footprint = 200 x 350

- -25 dB crosstalk level
- -1 dB insertion loss (center channel)
- 1.5 dB non-uniformity

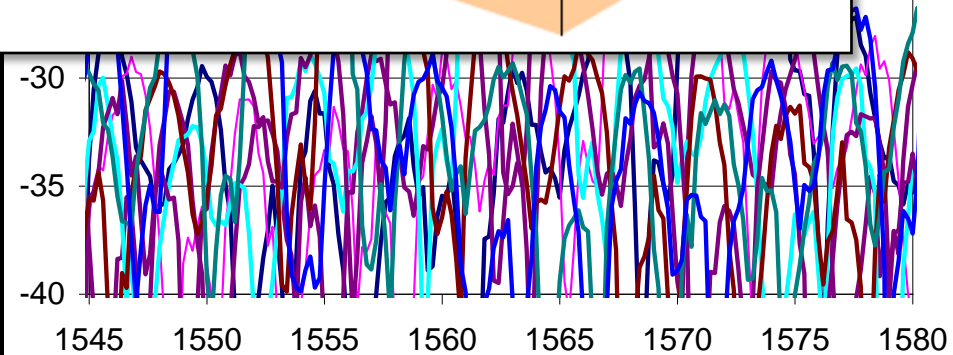
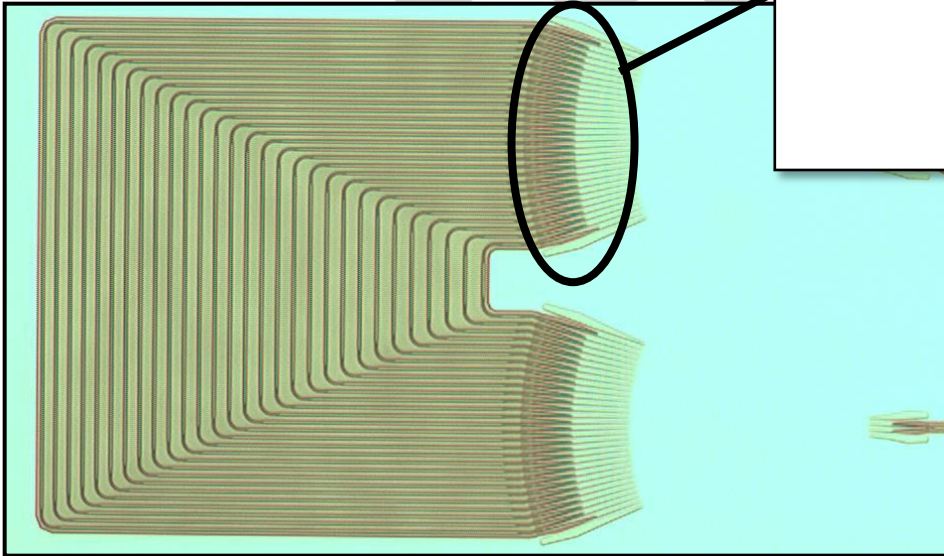
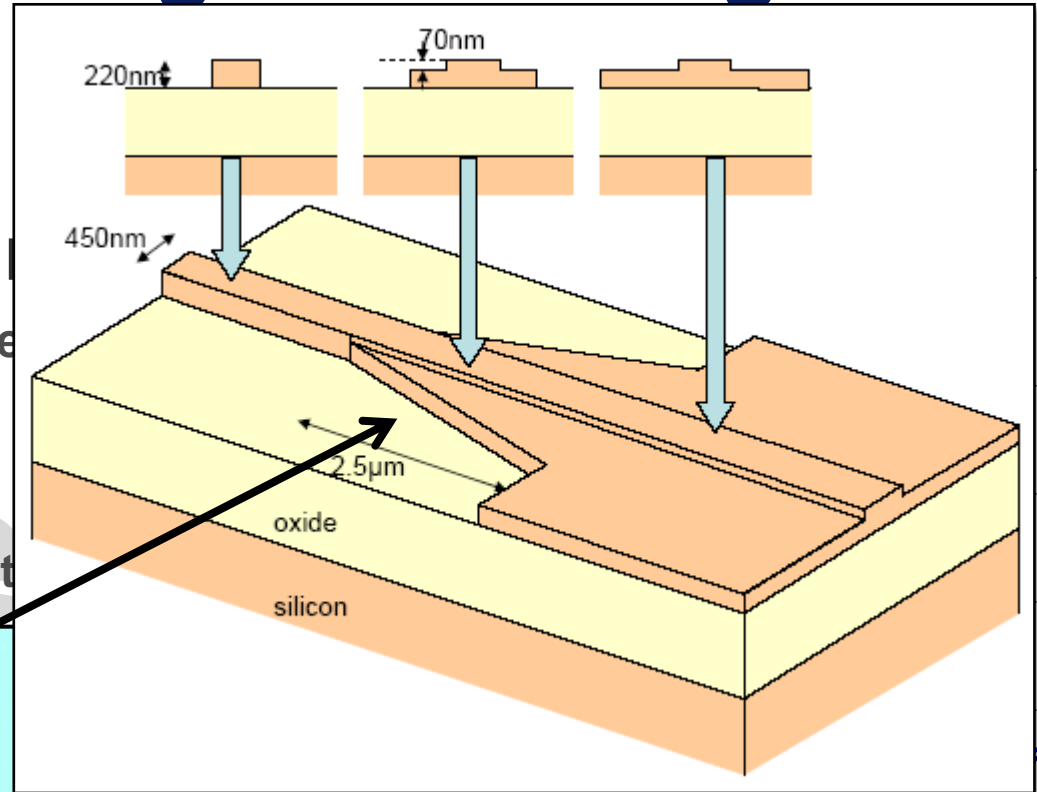

Arrayed Waveguide Grating

8-channel, 400GHz

FSR = 30nm

footprint = 200 x 350

- -25 dB crosstalk level
- -1 dB insertion loss (center channel)
- 1.5 dB non-uniformity

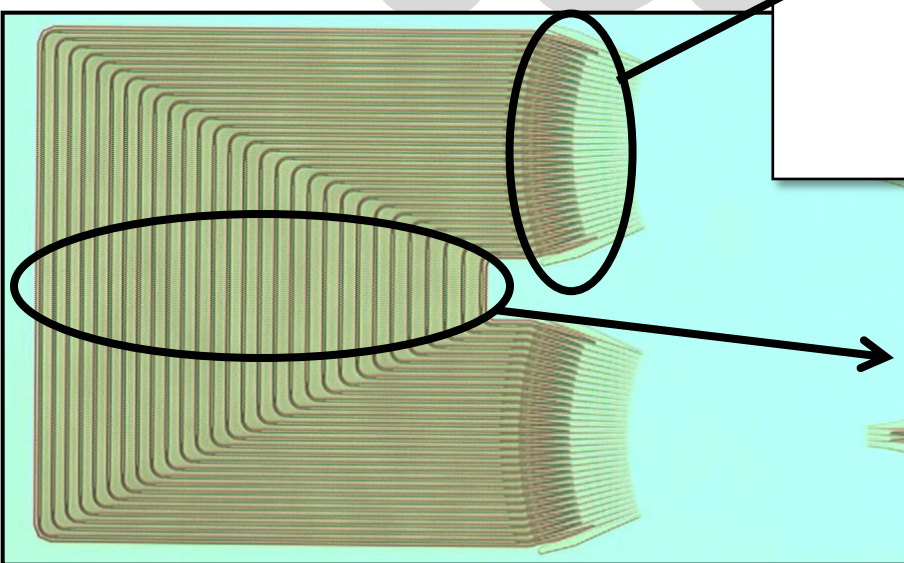
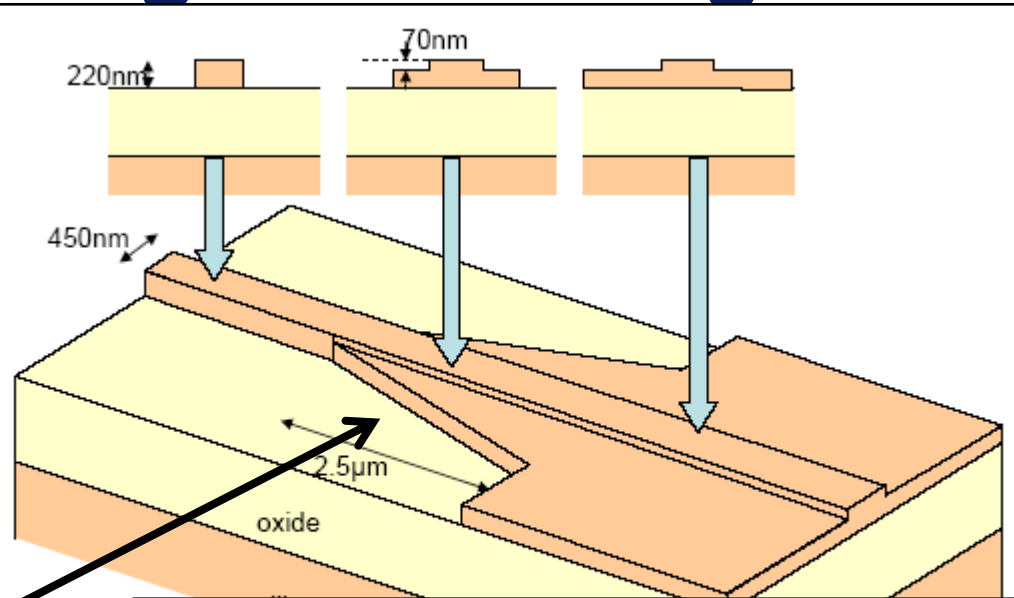

Decrease phase errors

- Use wider waveguides

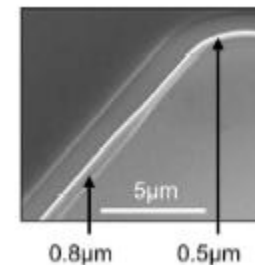

- Align waveguides to grid

- See also: P. Dumon, PhD thesis UGent 2007 (<http://photonics.intec.ugent.be>)

Use of shallowly etched waveguides for crosstalk reduction

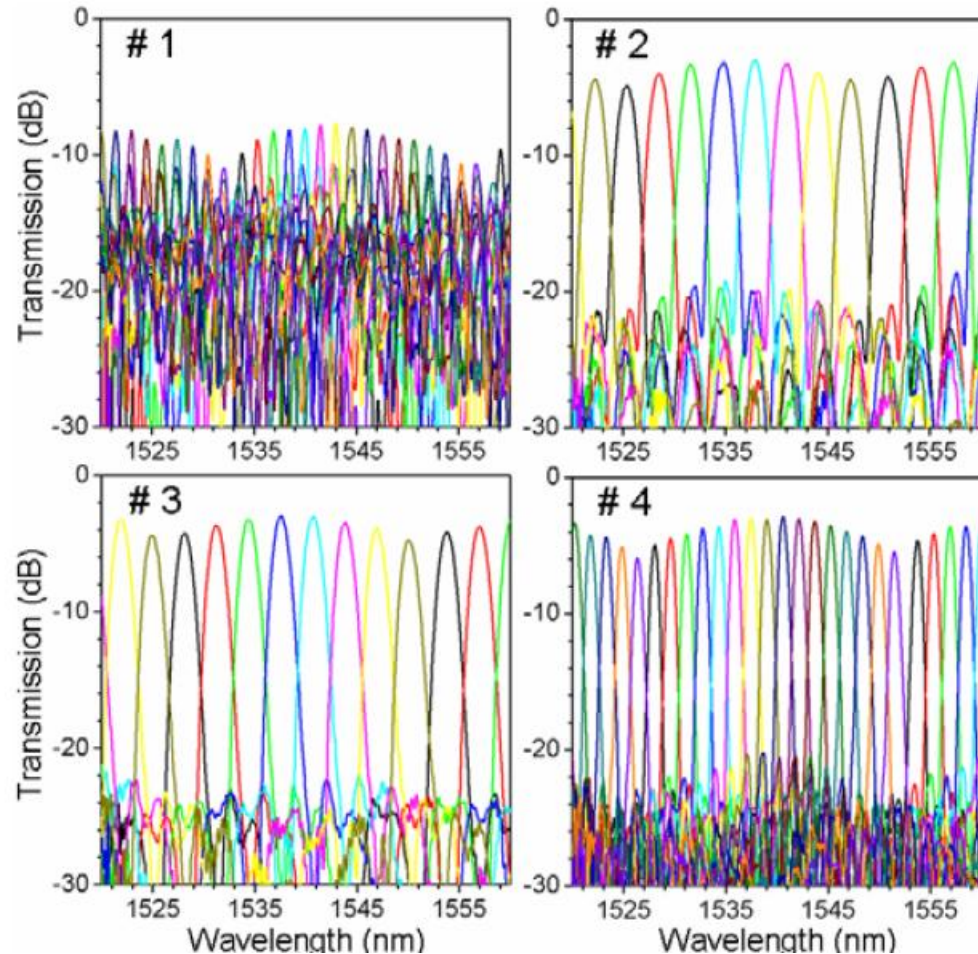
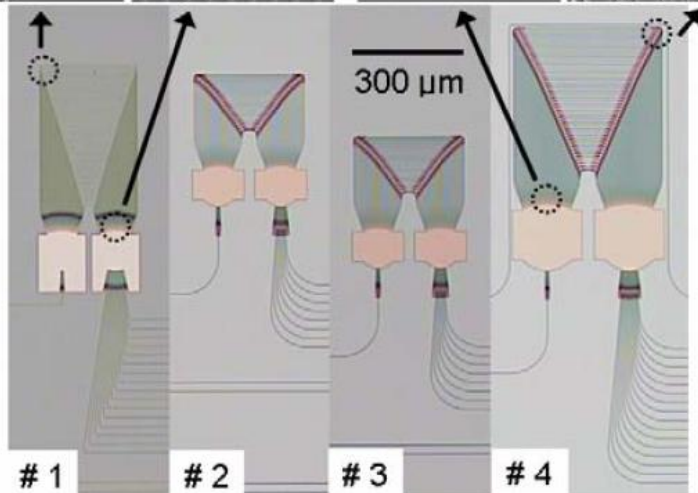
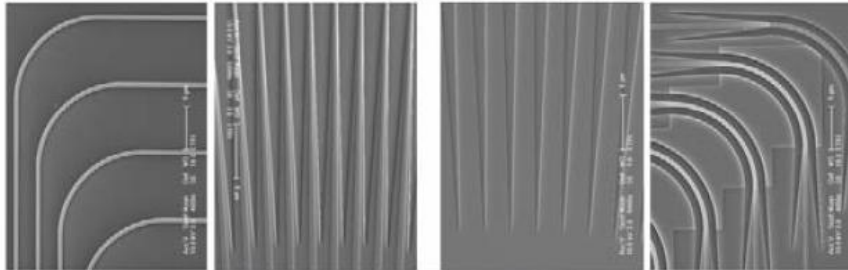

DJ Kim e.a. PTL 20 (17-20) p 1615 (2008)

Arrayed Waveguide Grating

Example: 320GB/s receiver

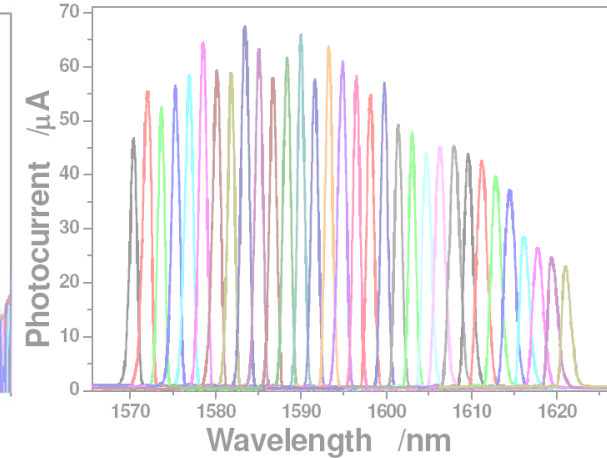
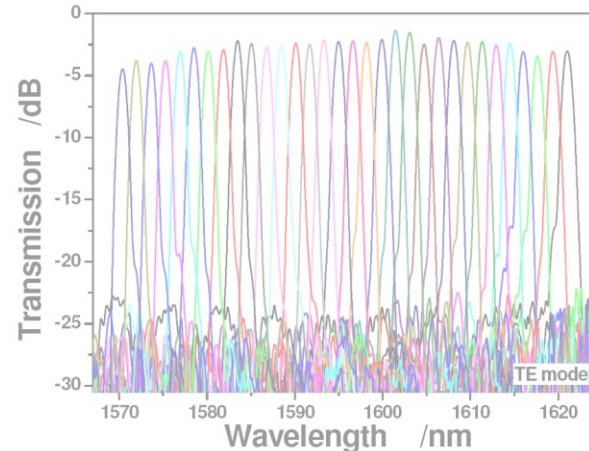
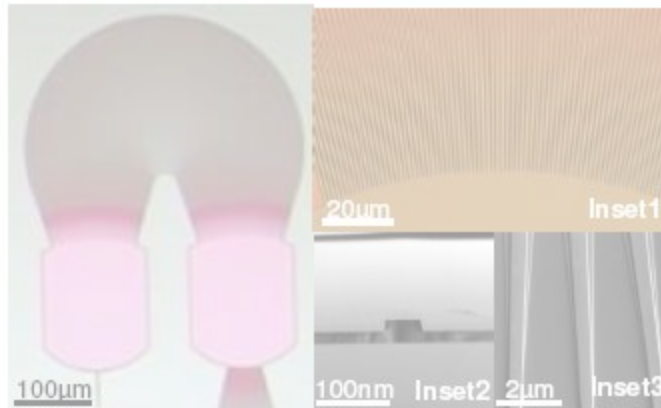

Fang e.a., OE 18 pp. 5106 (2010)

Silicon AWG for wavelength selective operations

- 😊 Channels spacing globally fixed
- 😊 Low loss (1dB)
- 😊 1 x N and N x N operation with same device
- 😞 Crosstalk > 25dB difficult to obtain
- 😞 Small channel spacings (≤ 100 GHz) difficult

Reproducibility

18 identical AWGs

- shift in channel peak $\sim 2.5\text{nm}$
- strong correlation with location of the AWG on chip

Possible causes

- center-to-edge on wafer
- lithography scanning
- mask fabrication
- mask loading

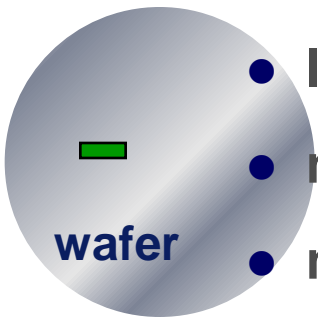
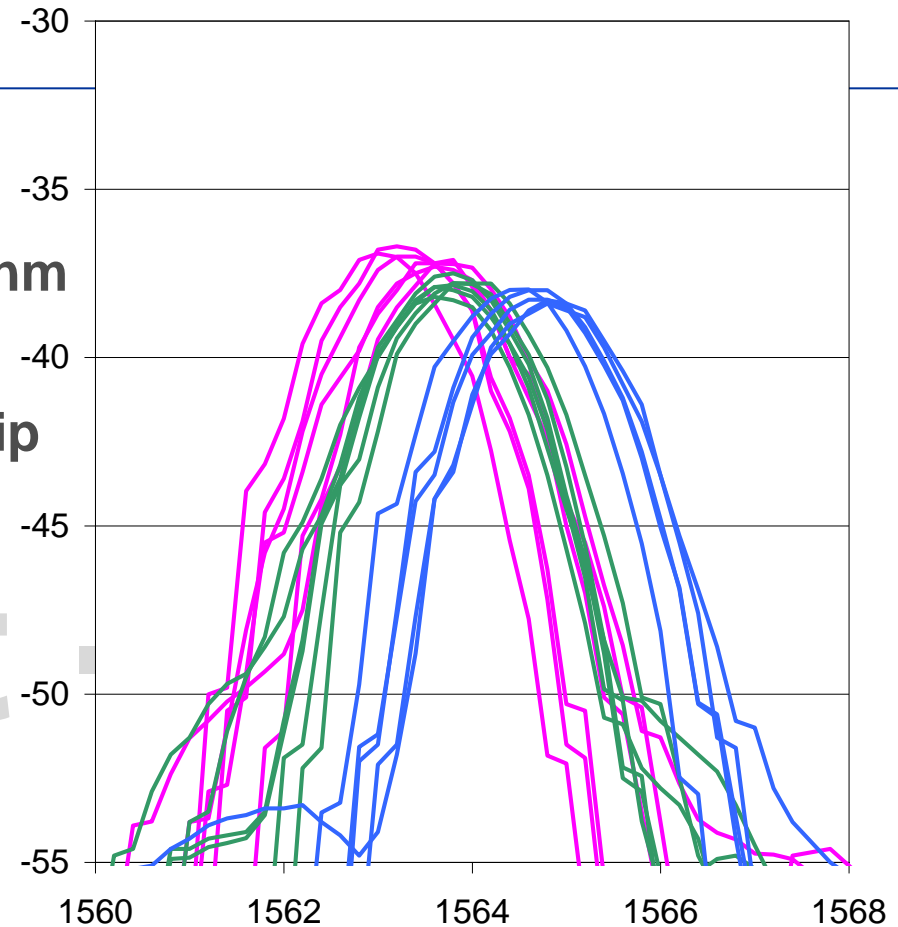

6mm

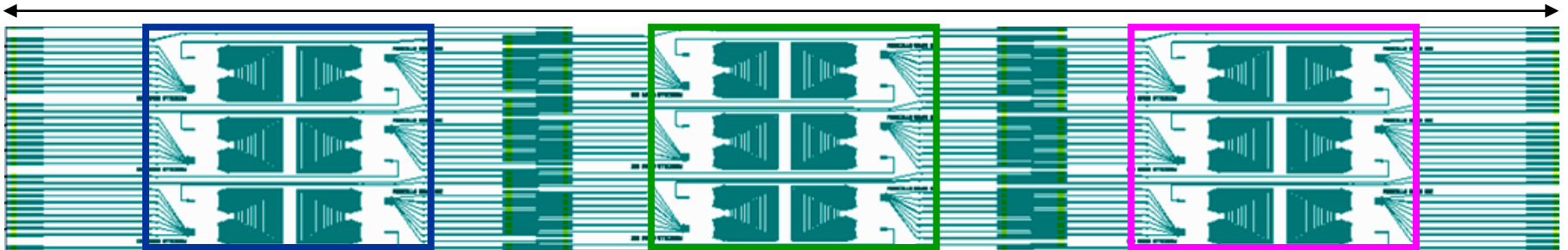

Fabrication uniformity

Measurements: IR Camera setup

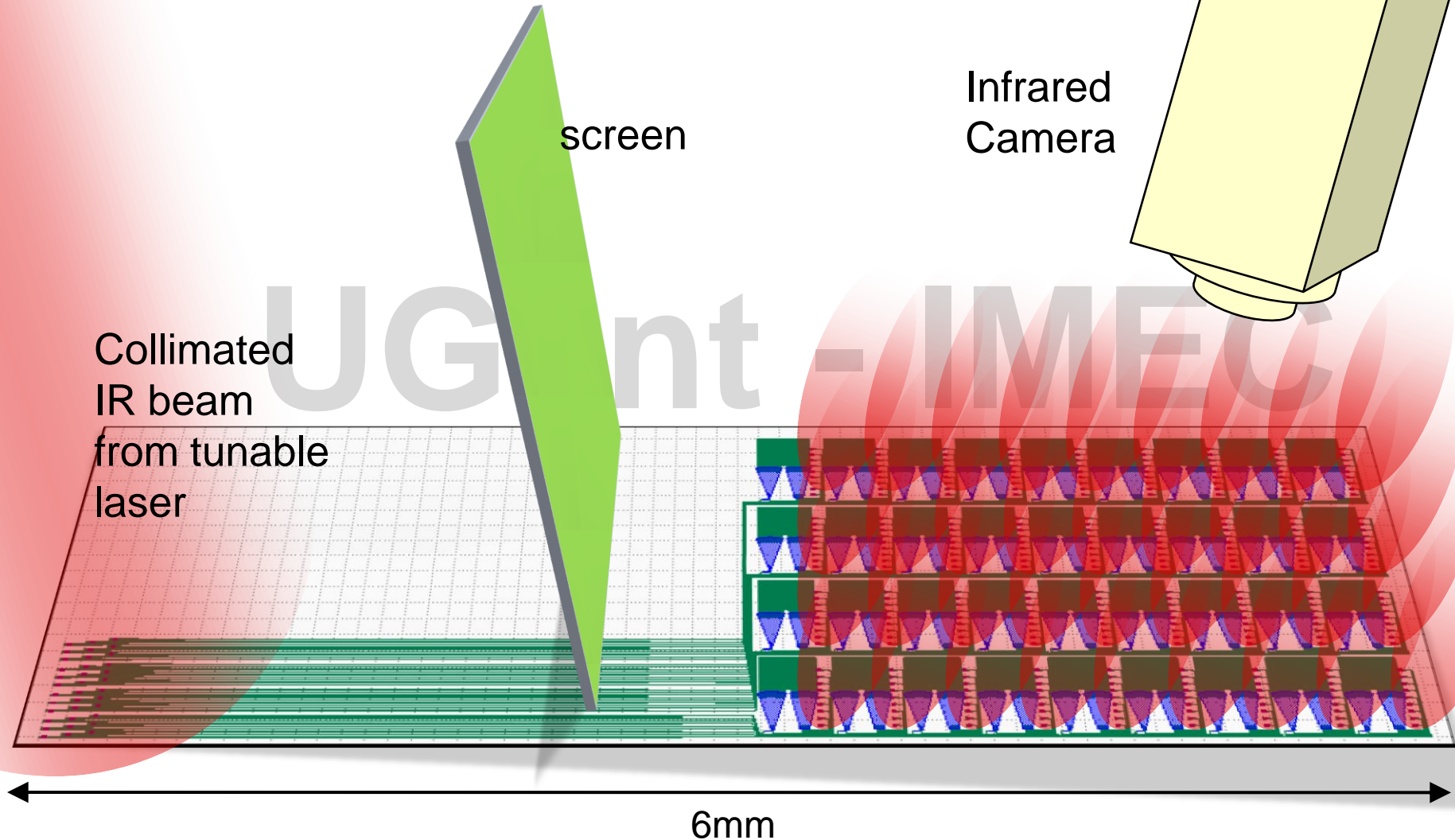

Camera view

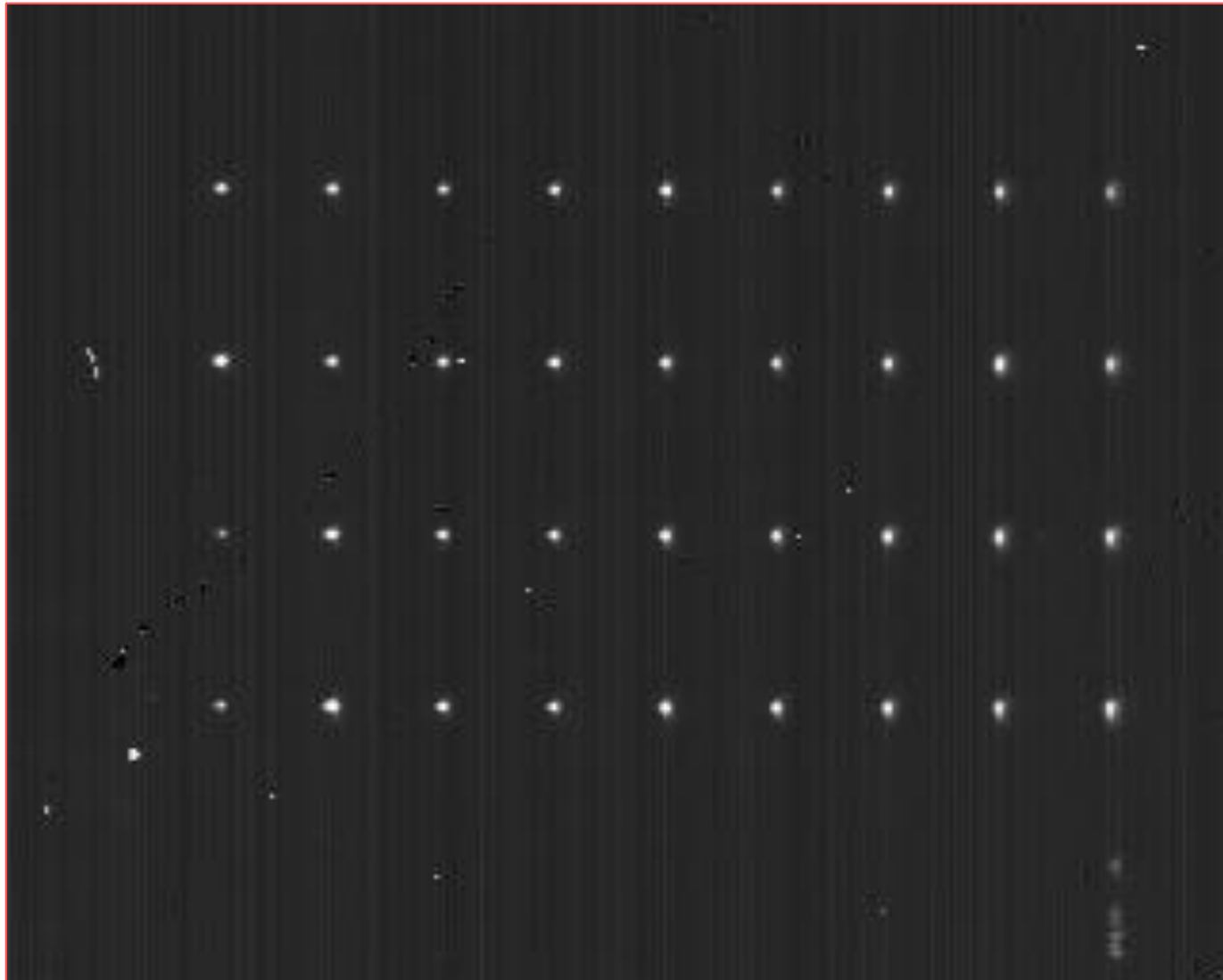

1588nm

C

Measurements

All rows

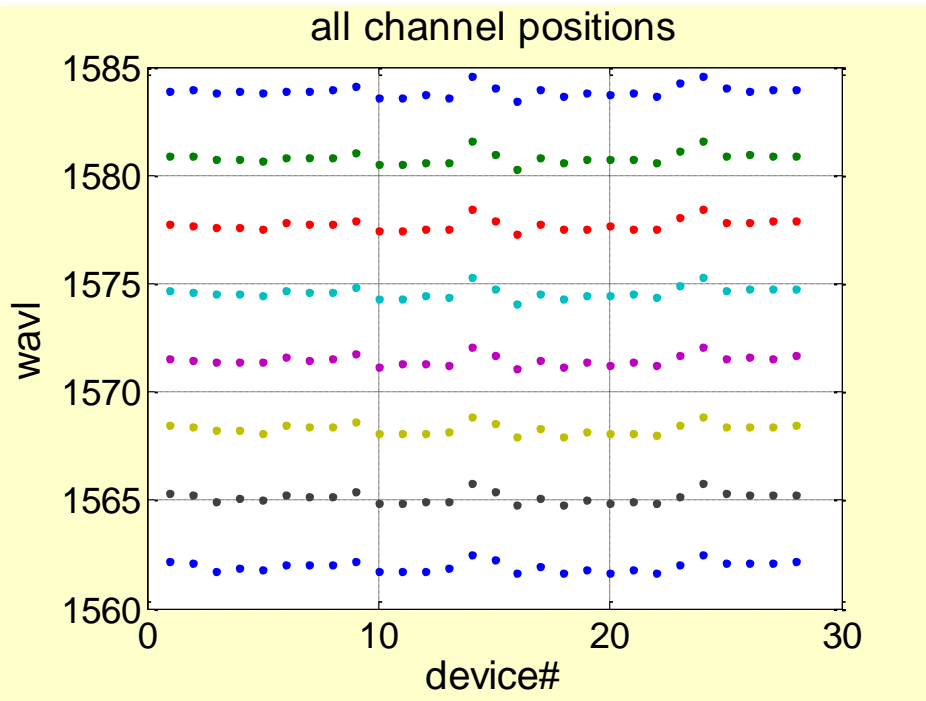
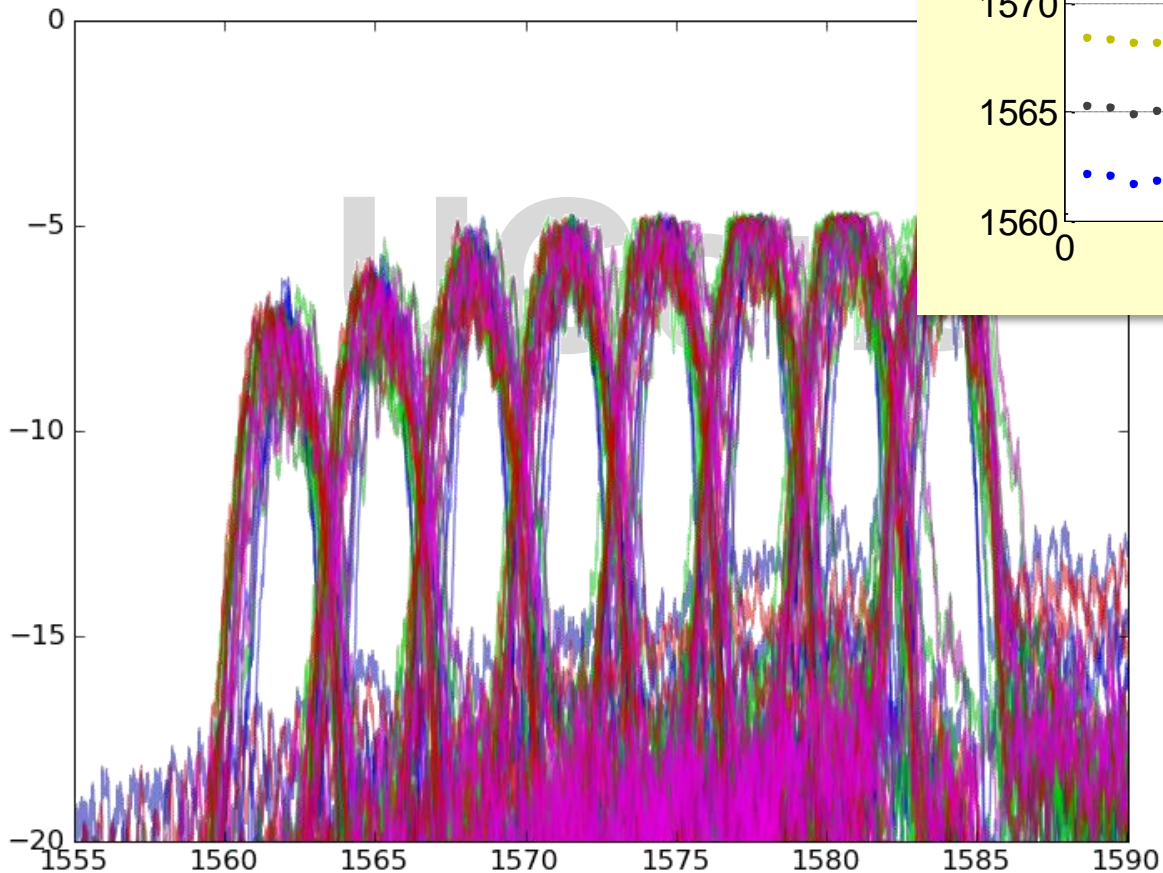

Challenges: sensitivity

Fabrication:

- Sensitivity to fabrication errors

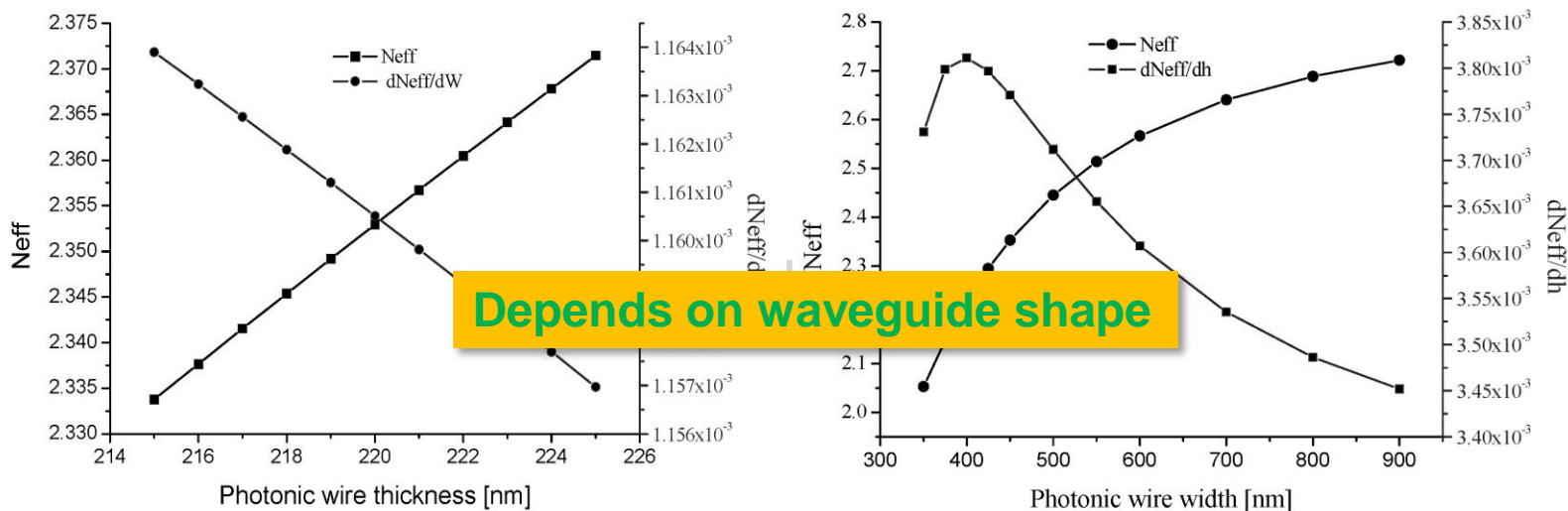

Roughly: 1nm variation in line width / thickness



1nm variation in central wavelength of device

Device uniformity

Influence of fabrication technology

248nm deep UV

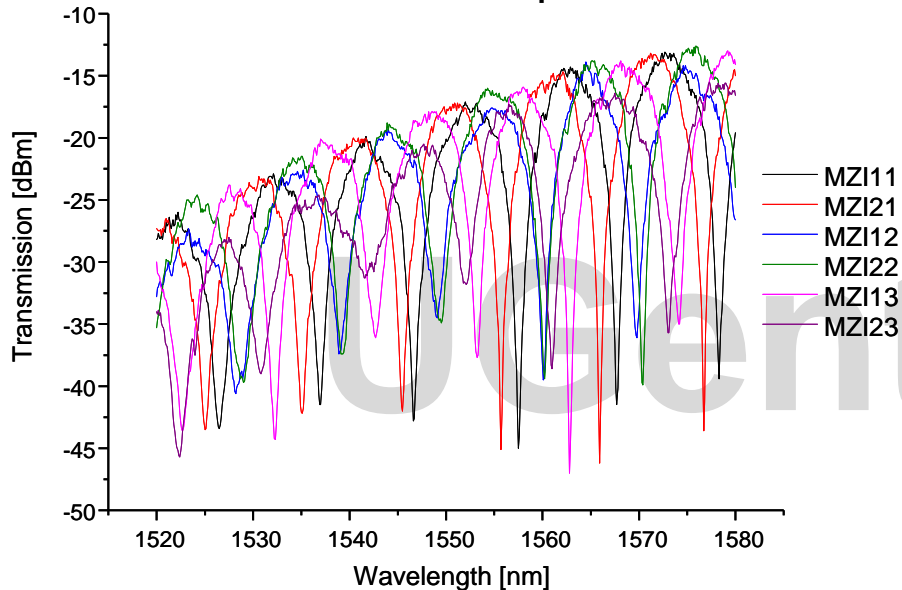

193nm deep UV

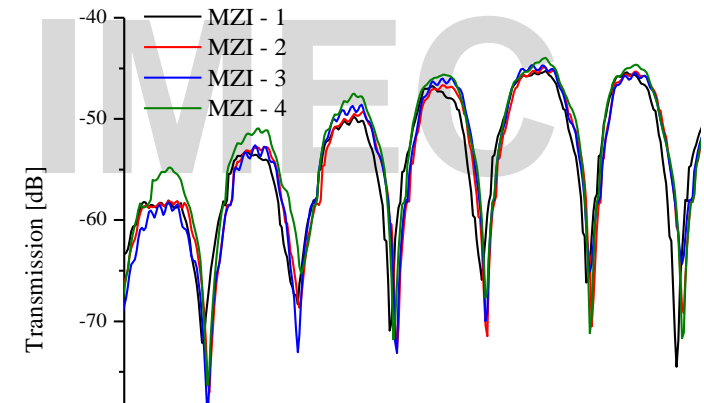

- 6 MZI's located 2mm apart
 - 248nm very far of from specs
 - 193nm <2nm variation over die

Wafer Uniformity

Thickness variation over **incoming wafer** (SOITEC[©])

- 4nm variation within wafer
- 3nm variation wafer-to-wafer (within lot)
- 4nm lot-to-lot

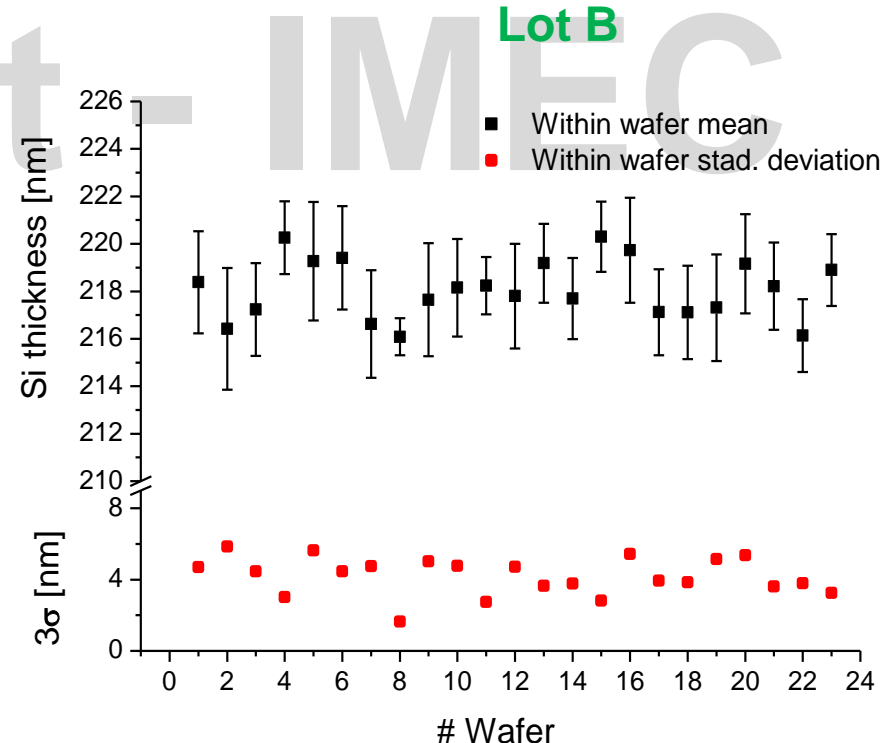
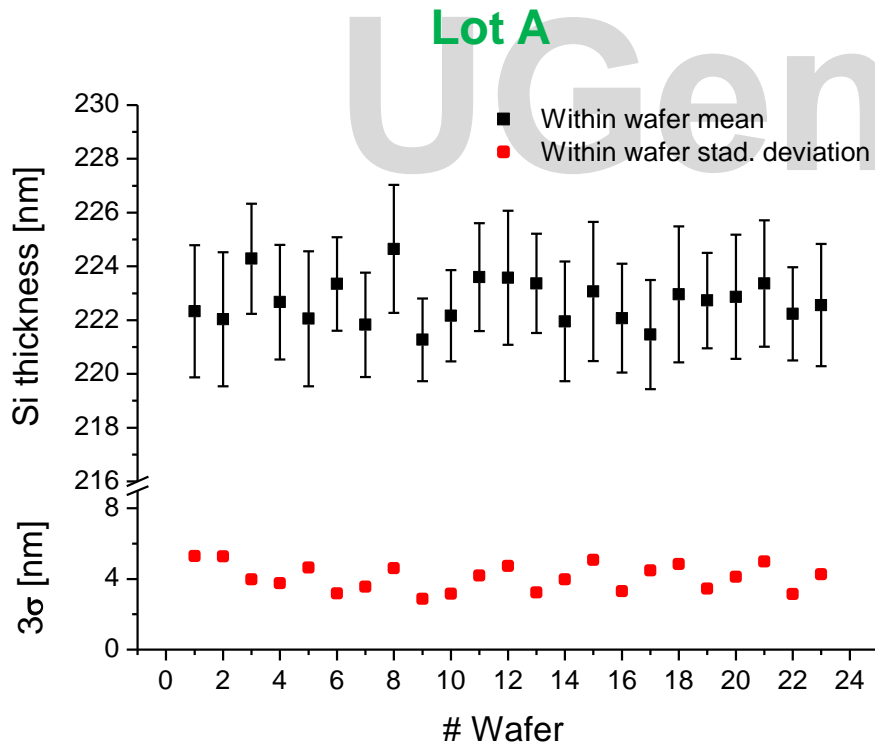
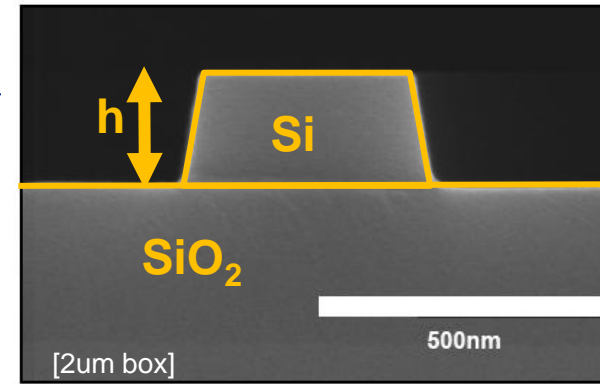

(circular within wafer pattern – determined by CMP process)

Wafer Uniformity

Linewidth variations

- Measured using top-down SEM

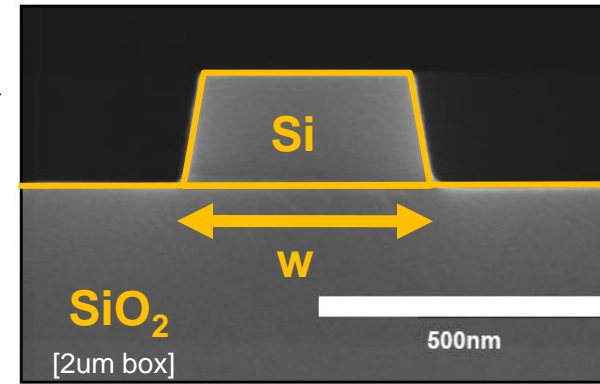

Variations in linewidth over 200mm wafer

- Less than 1% line width variation over 200mm wafer
 - Much better than typical CMOS specs
 - 1% is still 5nm !!
 - Pure passive, further post processing may increase problem (e.g. stress ...)
- SEM not accurate enough to characterize within die uniformity !!

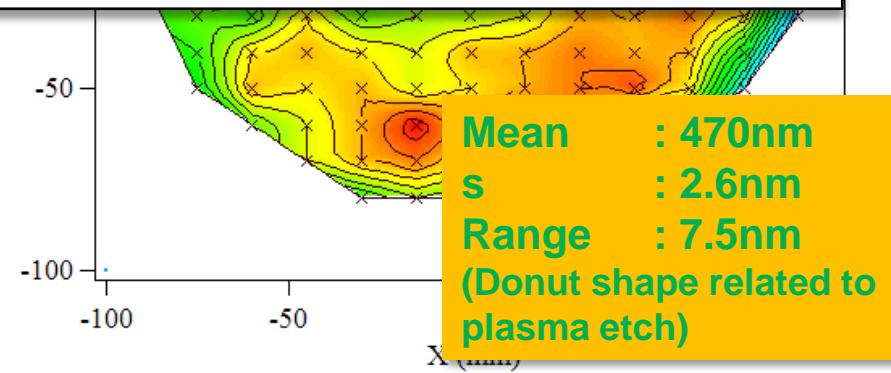
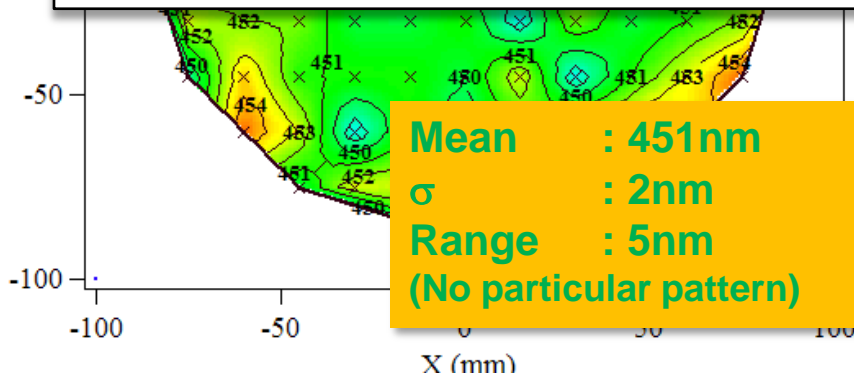

Manufacturability

Proposed solution

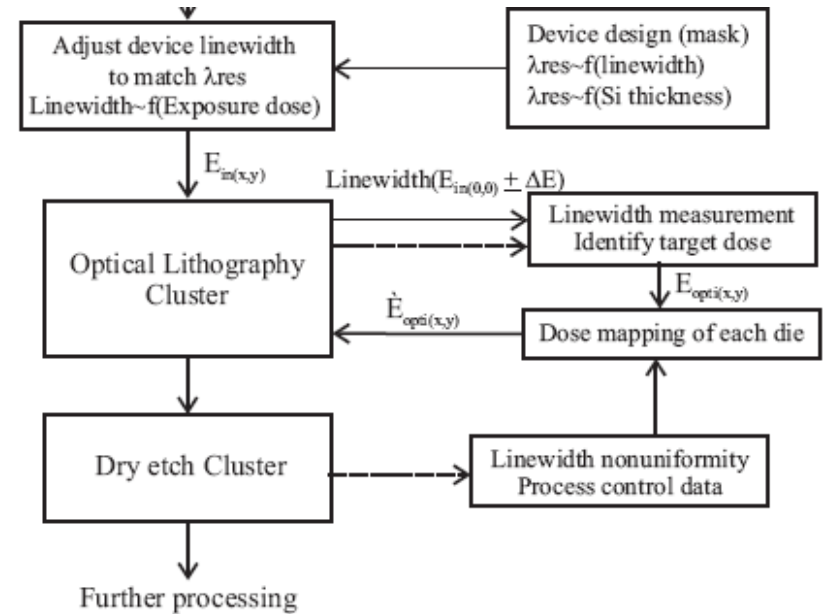
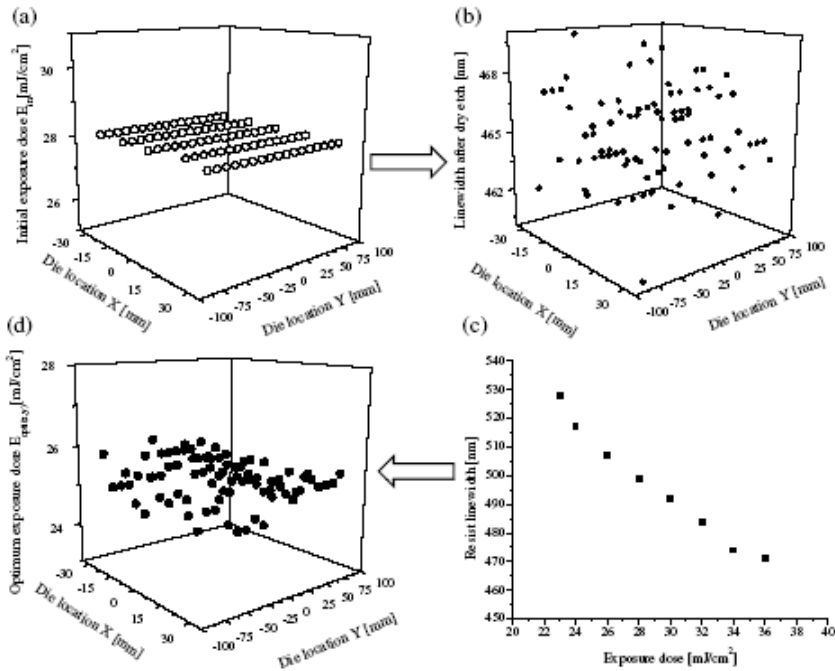

Planar Concave Gratings

Diffraction grating in slab waveguide

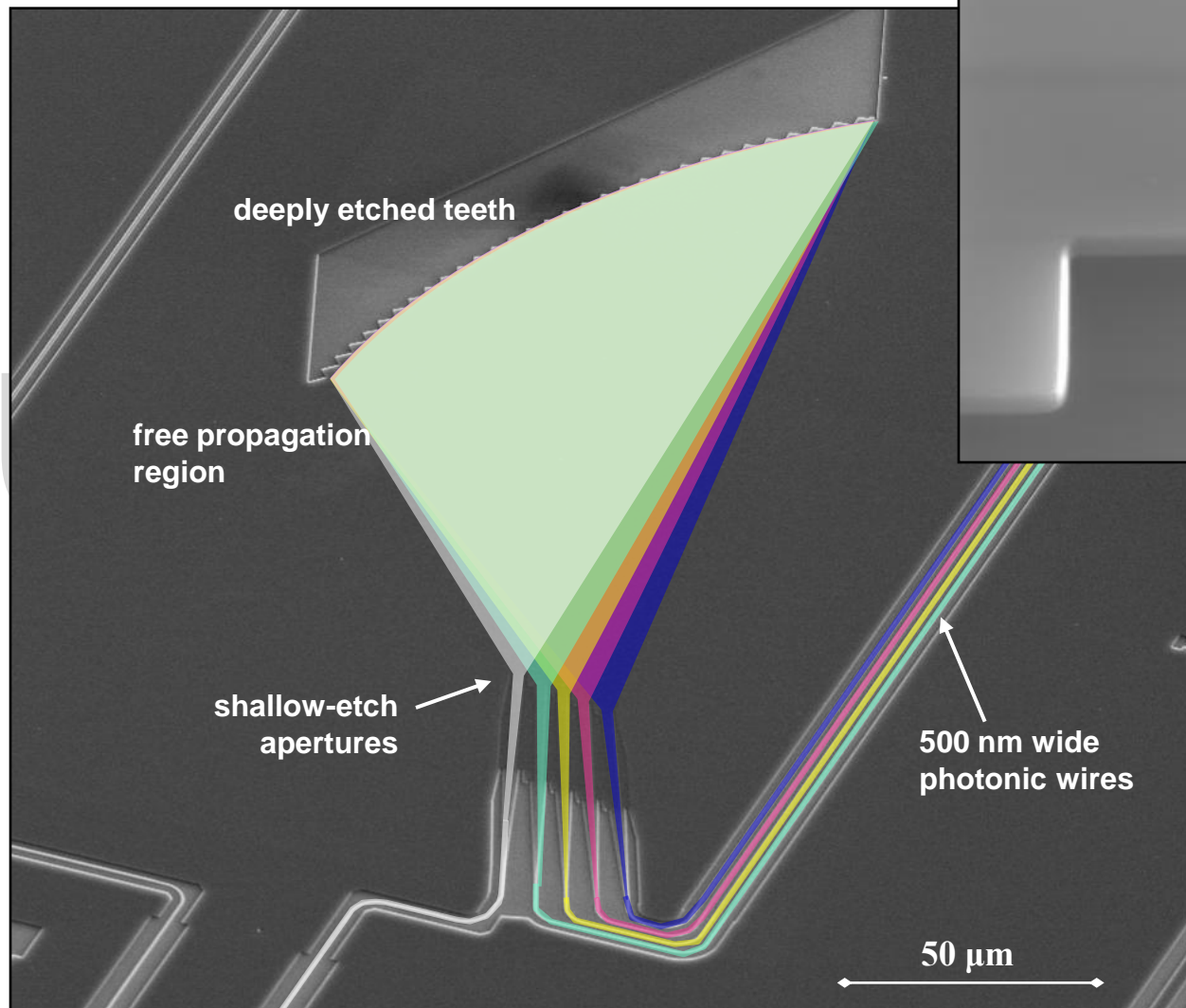

J. Brouckaert et al. JLT 25(5), p1269 (2007)

Planar concave gratings

Why PCG in nanophotonic silicon ?

- (Hopefully) Less sensitive to phase errors
 - PCG: transmission in slab
 - AWG: transmission in waveguides
- Properties less sensitive to process variations
- Compared to other material systems:
 - No deep etch required
 - Less sensitive to side wall

Horst, OFC 2010, OWJ3

angle

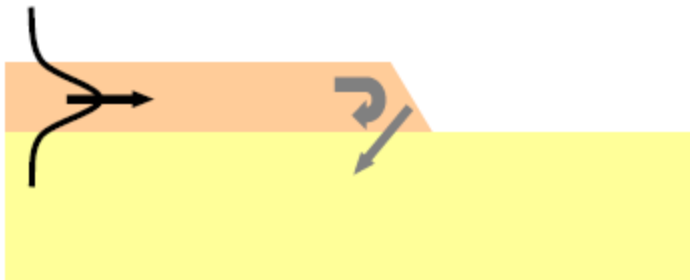

Si waveguide has high NA !!

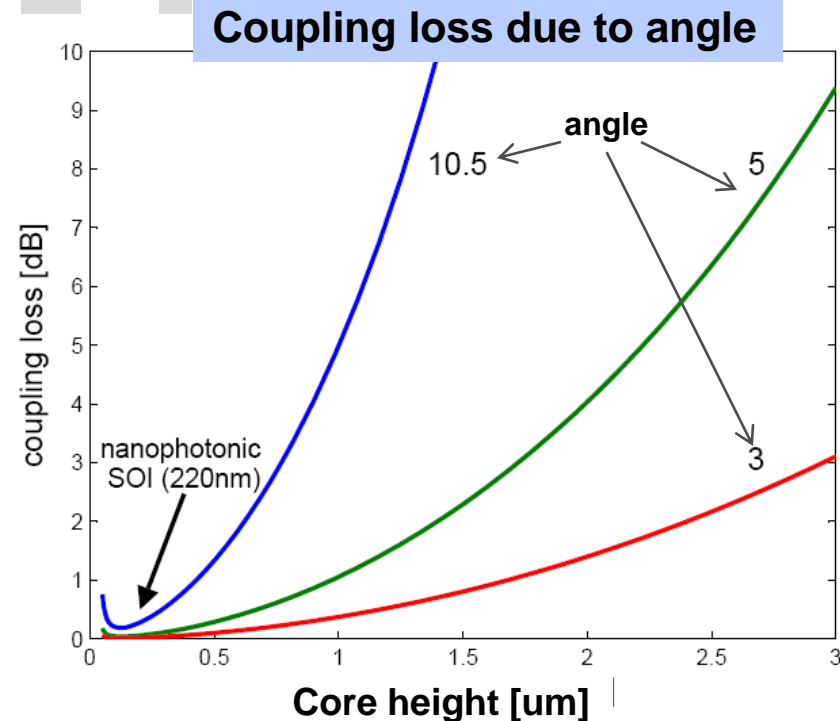

Grating Demultiplexer

Channel spacing: 20nm
Insertion loss: 7.5dB
Channel uniformity: 0.6dB
Crosstalk: better than -30dB
Footprint: 250 x 150 μm^2

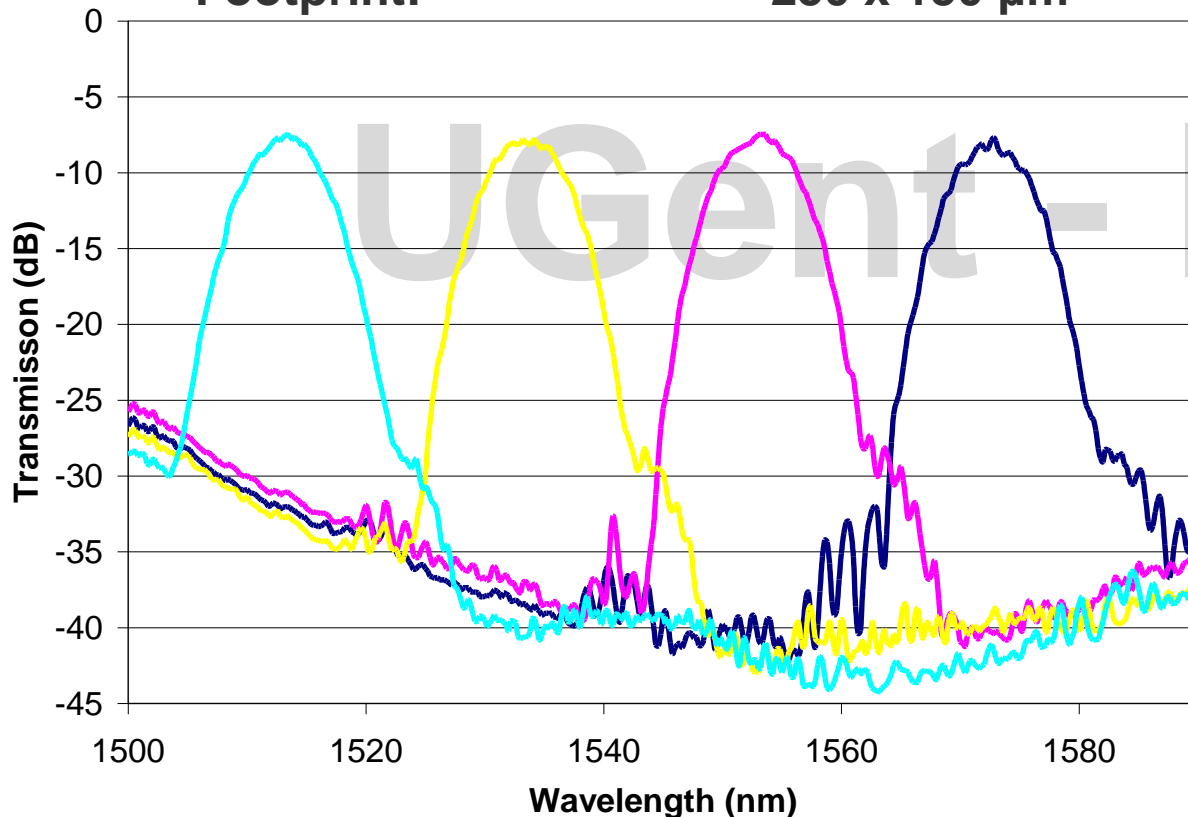

J. Brouckaert et al. JLT 25(5), p1269 (2007)

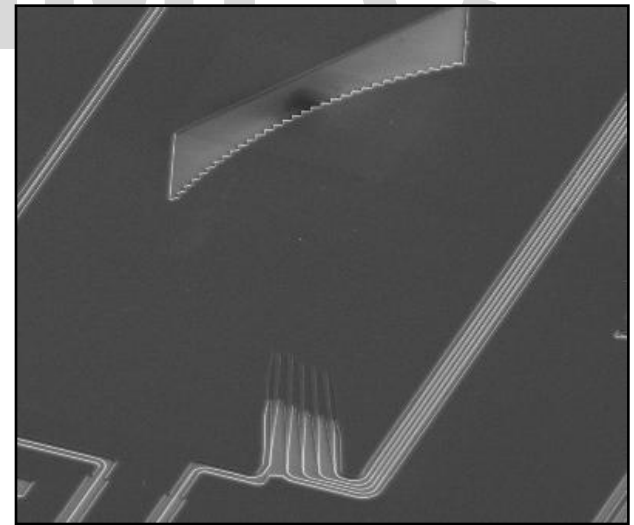
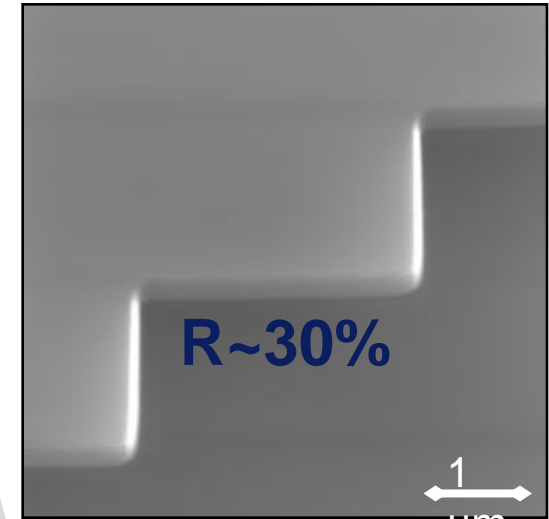

Grating Demultiplexer

High Fresnel reflection loss at grating ?

- Use metal coating
- Use DBR mirror
- Use TIR mirror

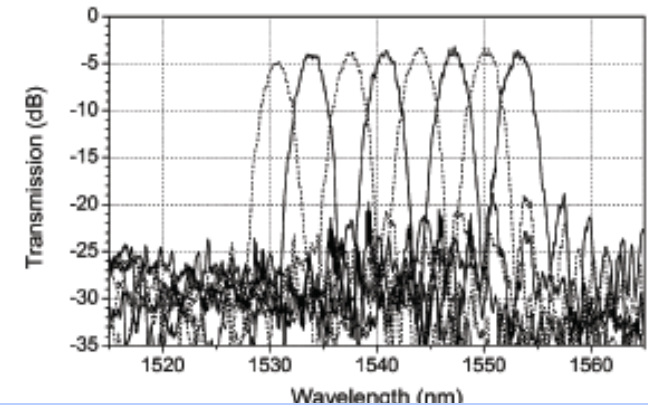
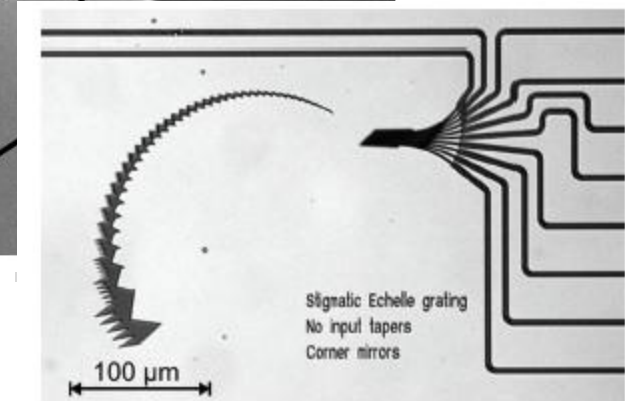
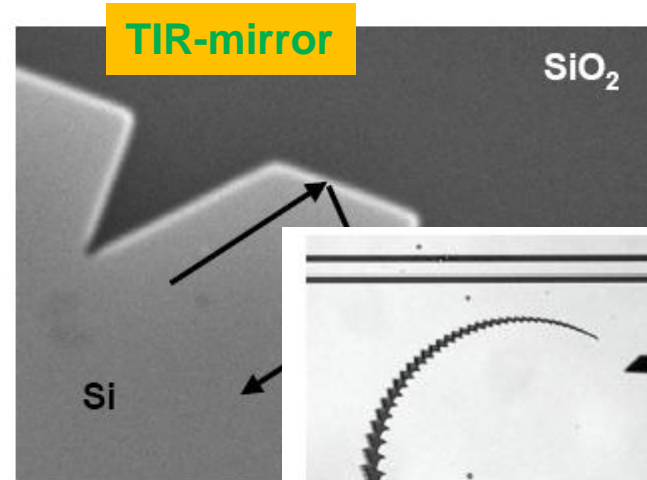
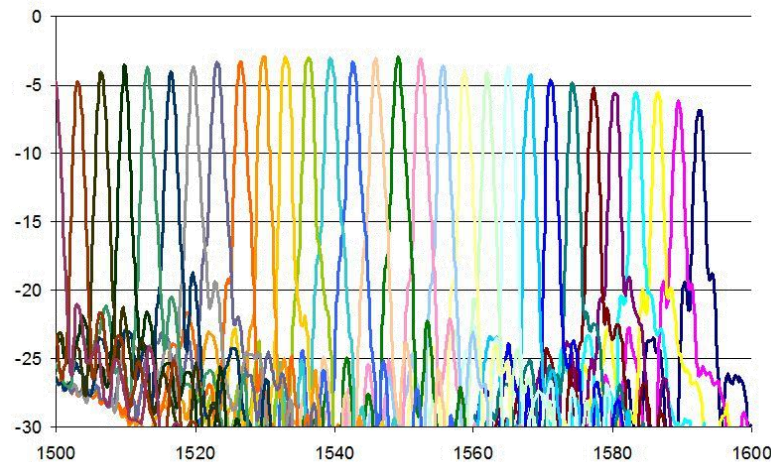
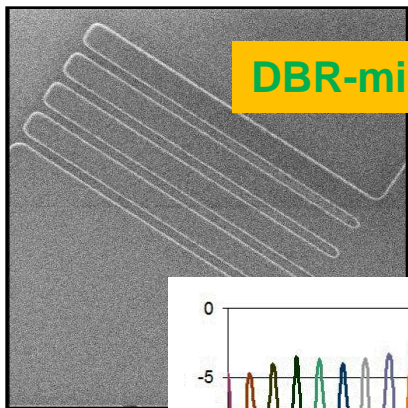

Ring resonators

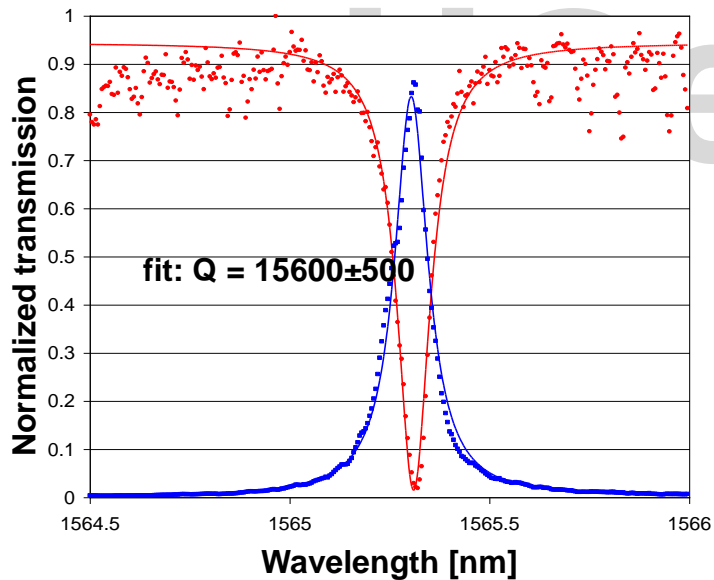
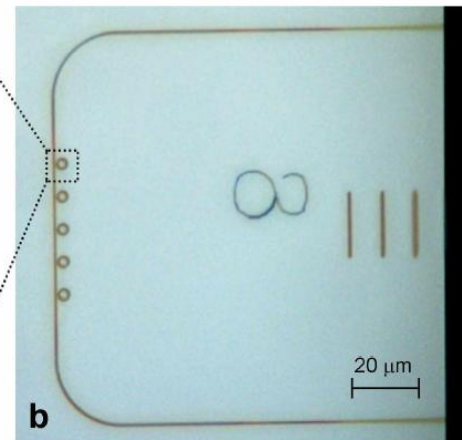
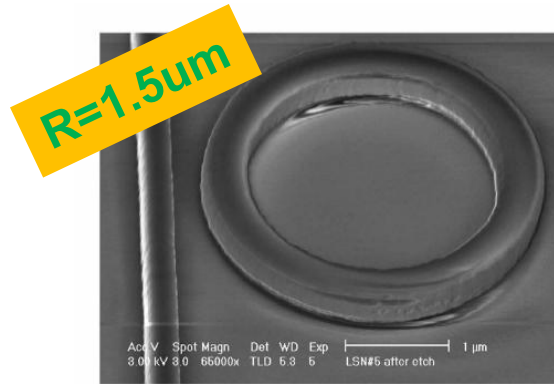
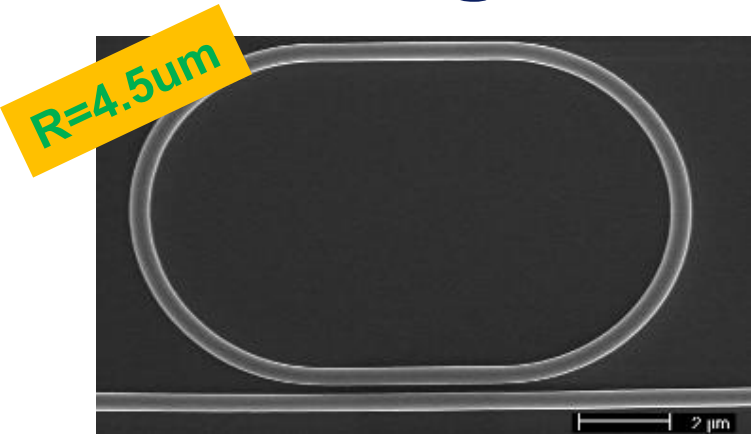

a

b

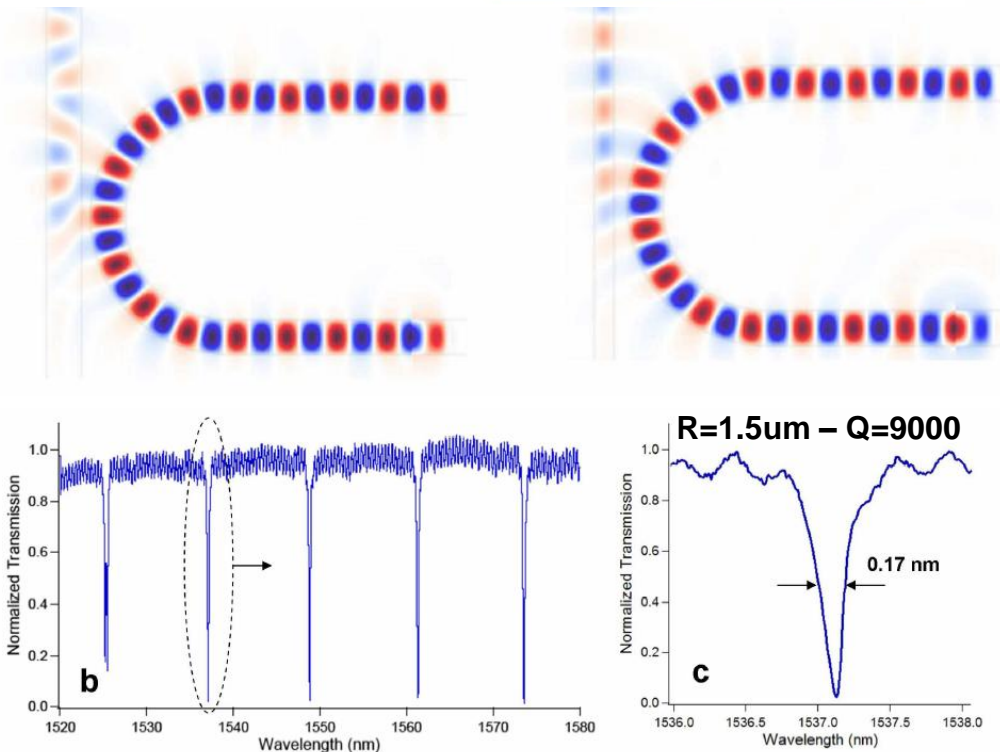

Ring resonators for sensing

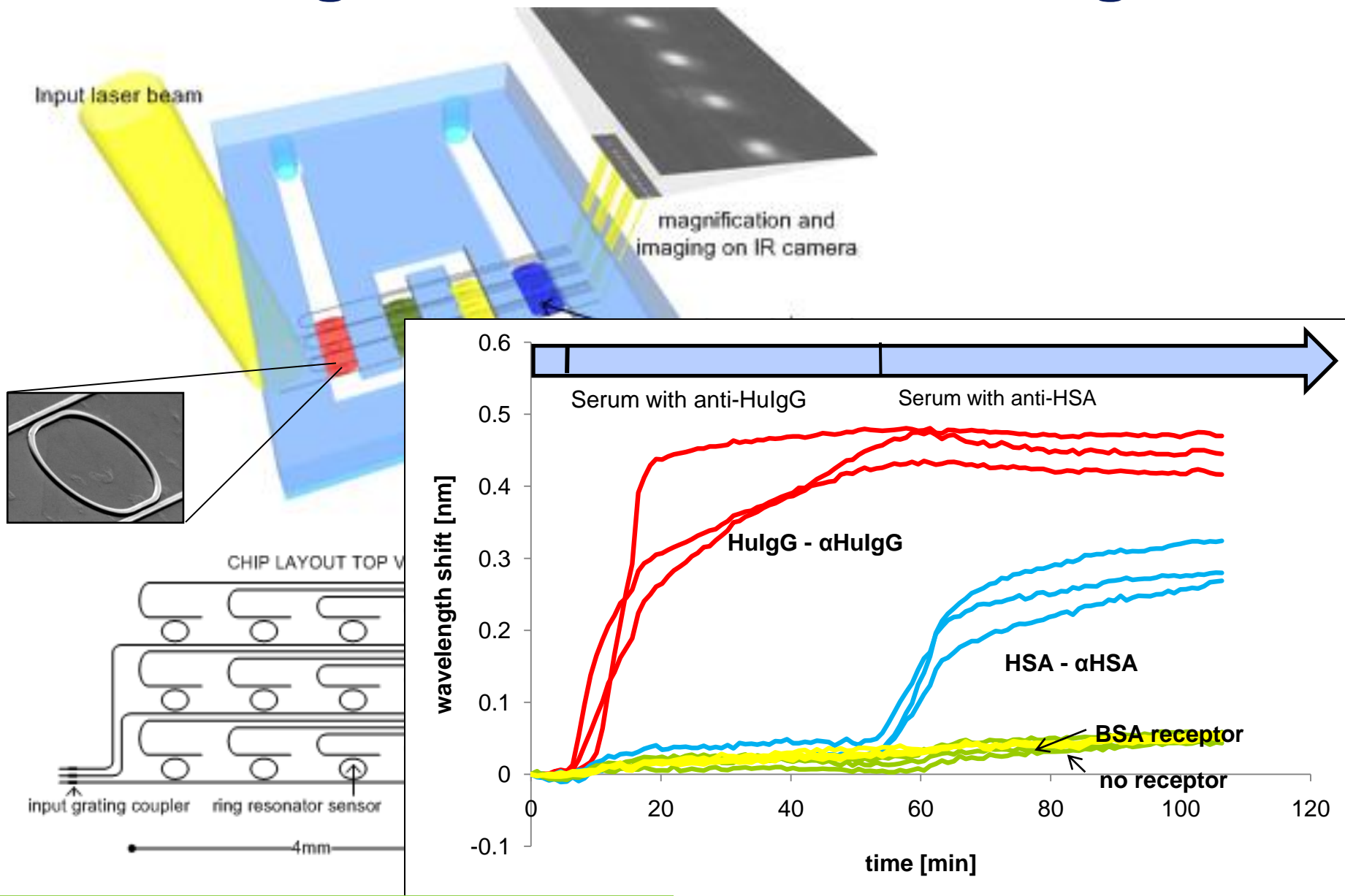

Ring resonator based devices

For applications in data- and telecom

- Need **multi-ring devices** with tailored pass band

Layout and channel transfer

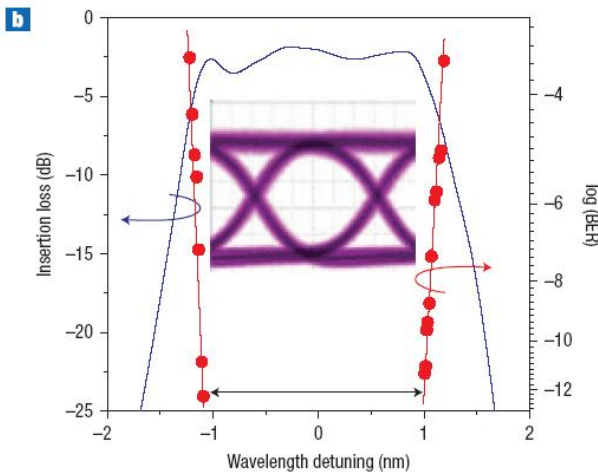
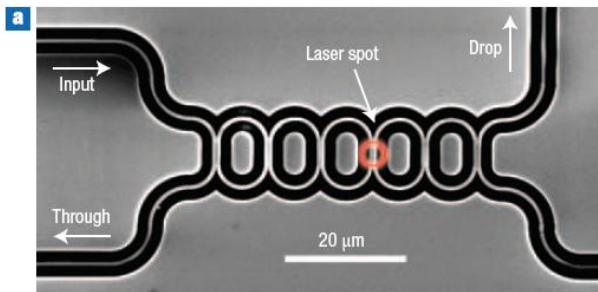

Response of 8-channel device

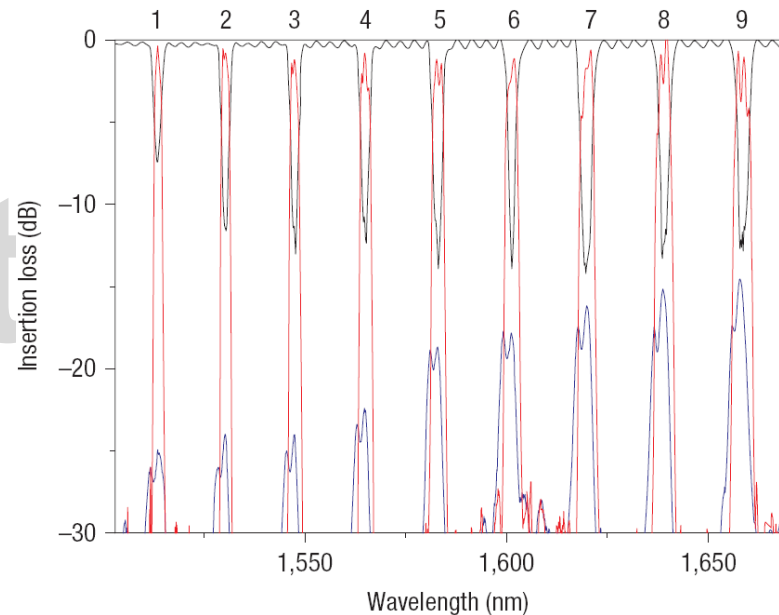

Switching 40Gb/s signal using probe

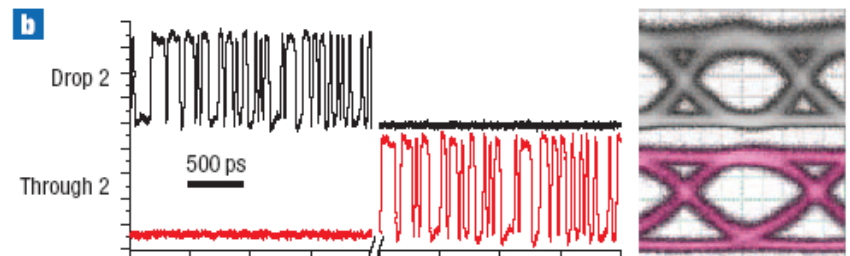

Higher order devices

Hitless add-drop filter

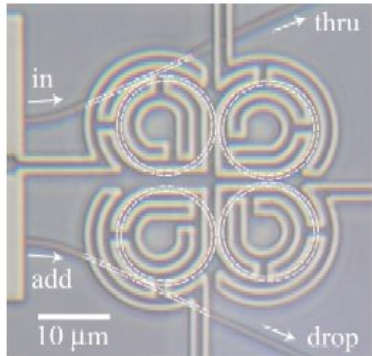

(a)

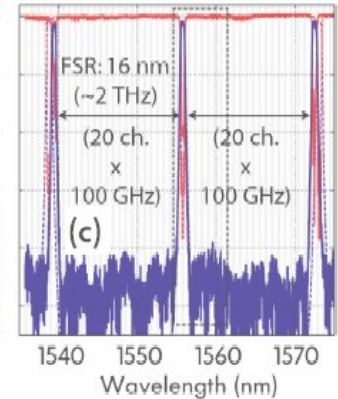
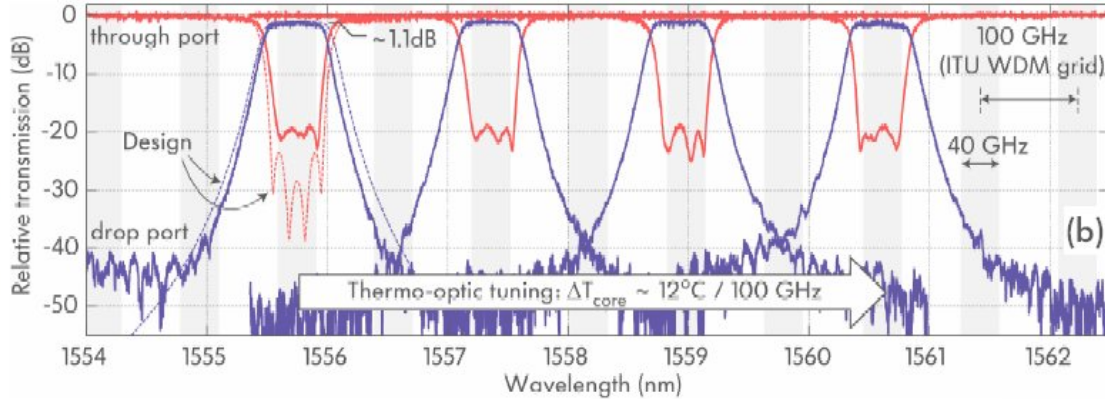

Popovic e.a. , OFC2008, paper OTuF4

Interleaver

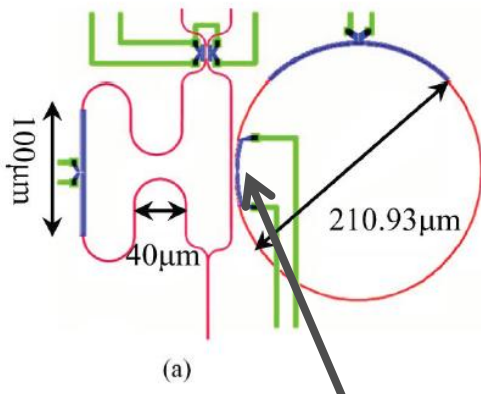

(a)

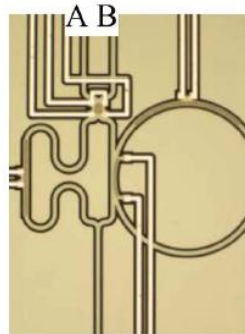

(b)

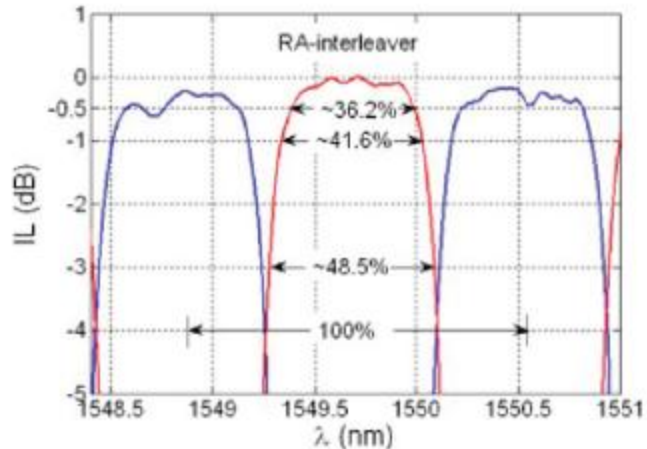

Asymmetric heating of directional coupler for optimizing coupling ratio

Song e.a. , IEEE PTL 20, pp 2165 (2008)

Thermo-optic effect

Silicon strongly temperature dependent

- Roughly: 80pm/K

P. Dumon, PhD Thesis UGent (2007)
(<http://photonics.intec.ugent.be>)

Opportunity for tuning & trimming devices



Gnan e.a., Photonics in Switching 2007, paper TuB3.3

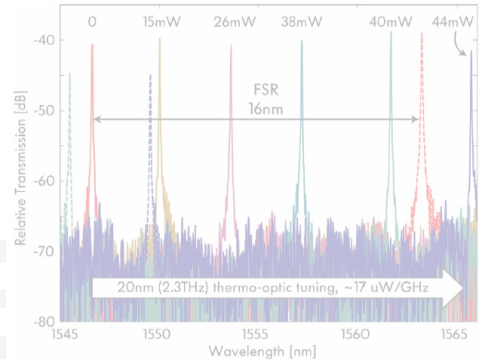

17uW/GHz

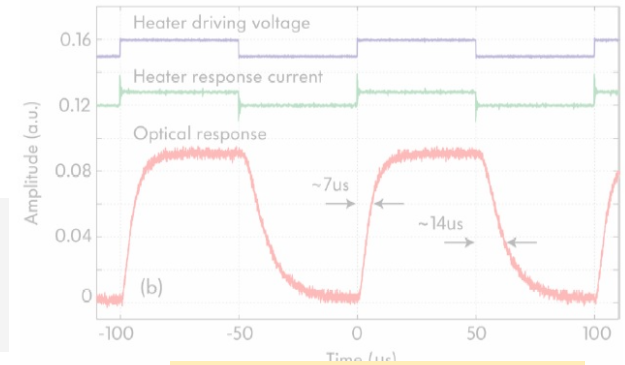

~10us switching

Problem for fixed filters: need for **athermal** devices

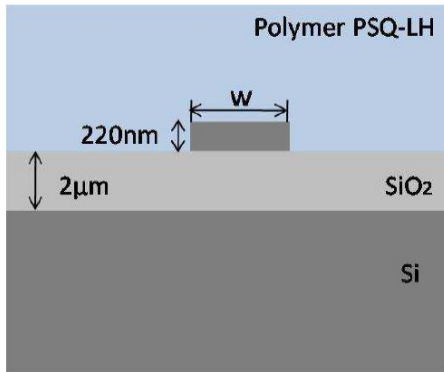

Teng e.a., OE 17 p.14627-14633 (2009)

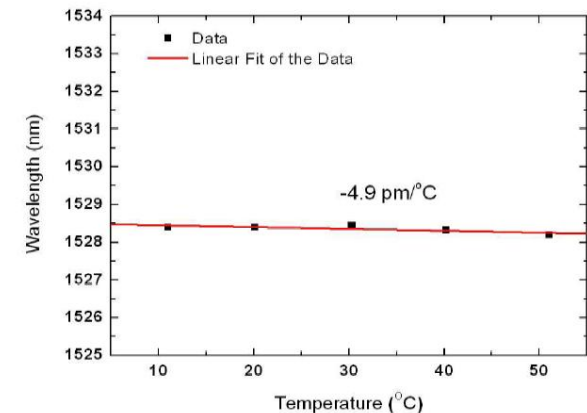
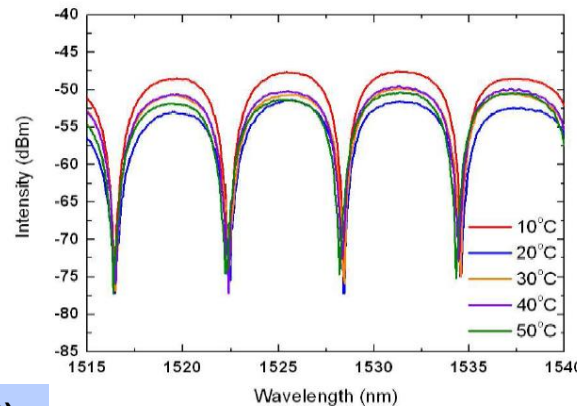

Fiber chip coupling

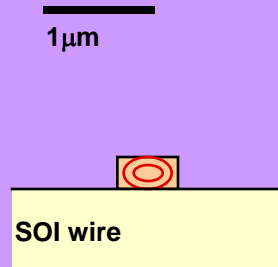

Single-mode fiber

We would like

- Low loss
- Broadband
- High coupling tolerance
- No facet reflections
- Waferscale testability
- Easy to fabricate
- A solution for the polarization problem

Two solutions

Two widely used solutions

Inverted taper

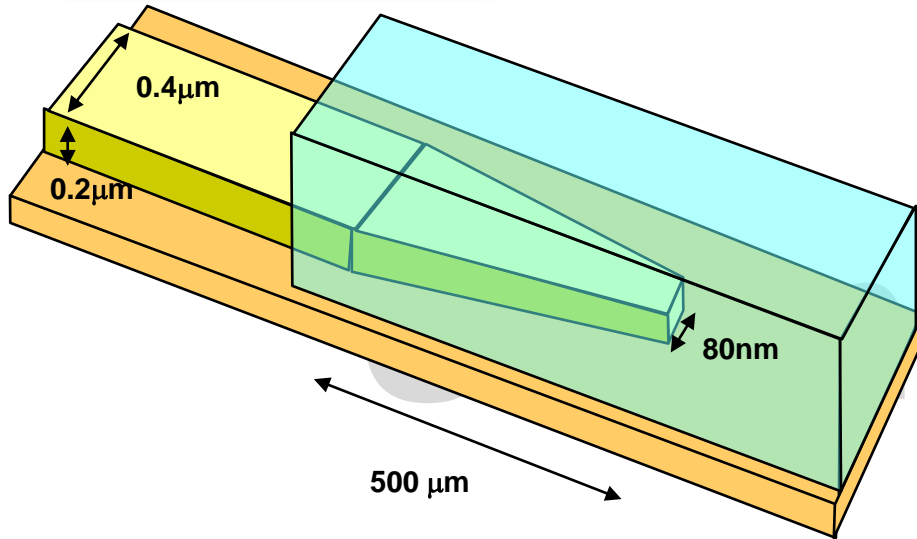

Grating coupler

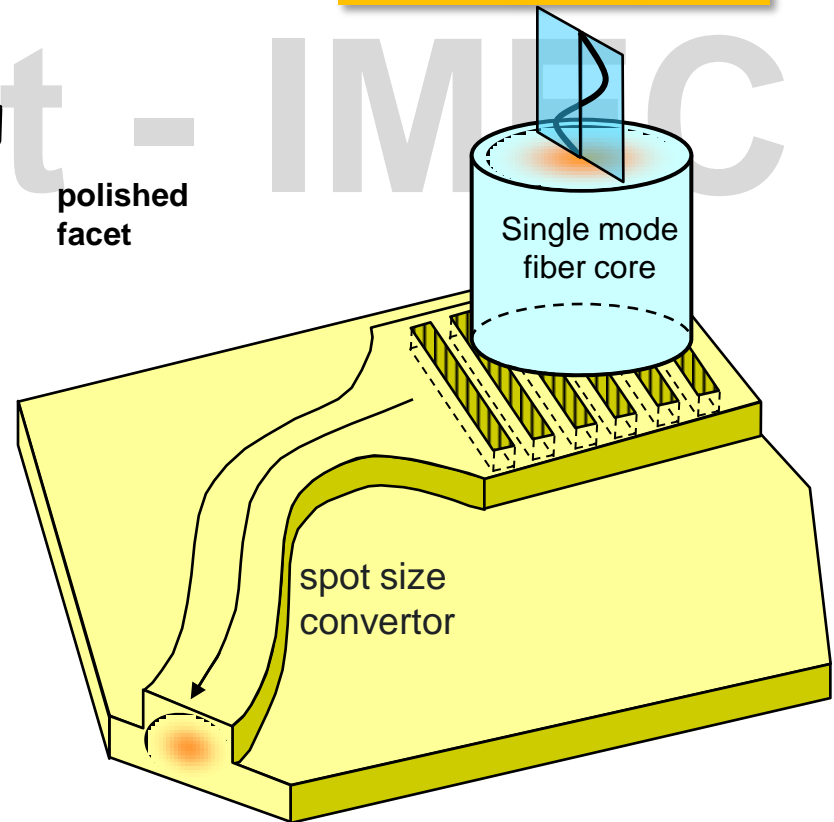

Comparison

Loss (best)	<1dB	<1.5dB
Loss (in real live)	3dB-7dB	5dB-7dB
Broadband	> 100nm	35nm (1dB)
Misalignment tolerance	1um (1dB)	2.5um (1dB)
Facet reflections	Low	-20dB
Waferscale testing	No	Yes
Fabrication	Additional layer Facet critical	Easy to difficult
Robustness	Facet preparation	Etch depth control
Polarization	Need additional	Build in polarization

High performance applications

Low cost applications + Testing

Polarization diversity

Process both polarizations separately

- split polarizations
- convert to the same polarization on the chip
- combine polarization back into the fiber

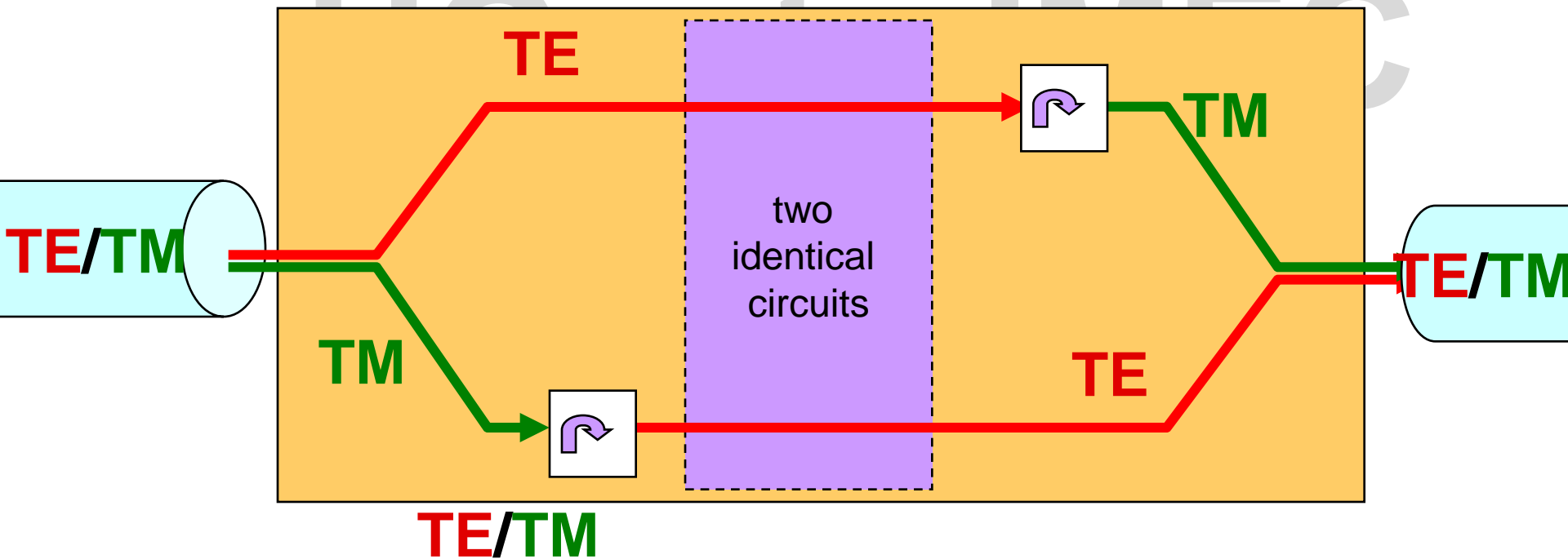

Polarization diversity

Polarization diversity with **inverted taper**

- Need on-chip polarization splitter + rotator

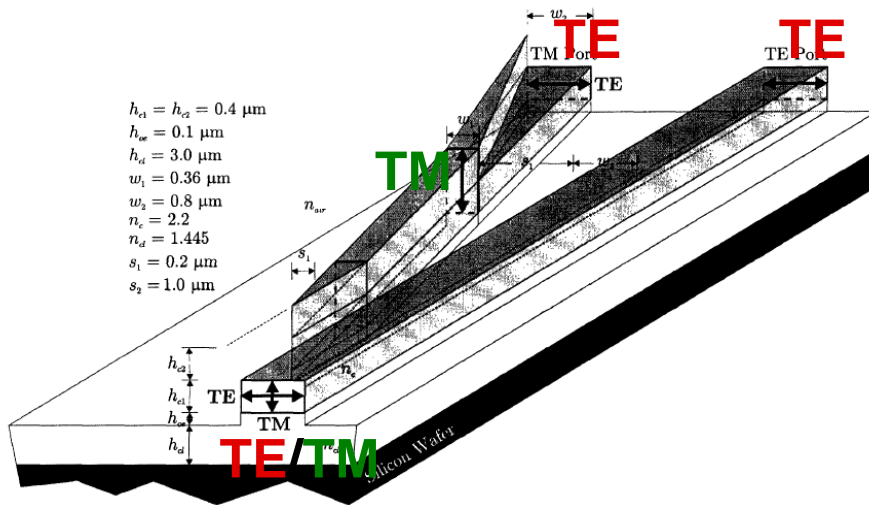

Watts et al, OL 30(9), p.937 (2005)

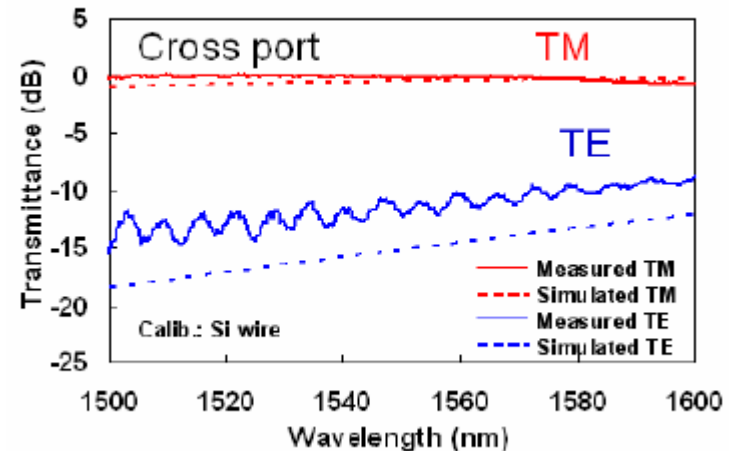
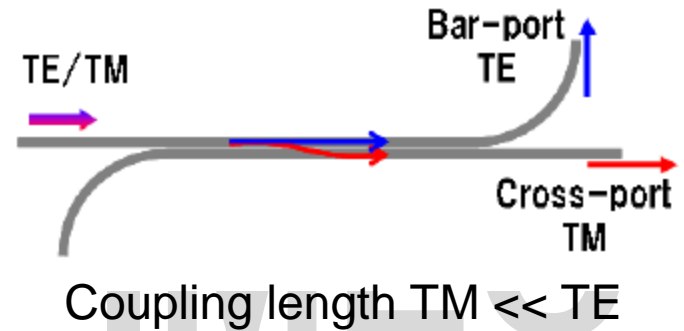

Fukuda e.a., OE 14(25), p. 12401 (2006)

Polarisation Diversity Circuit

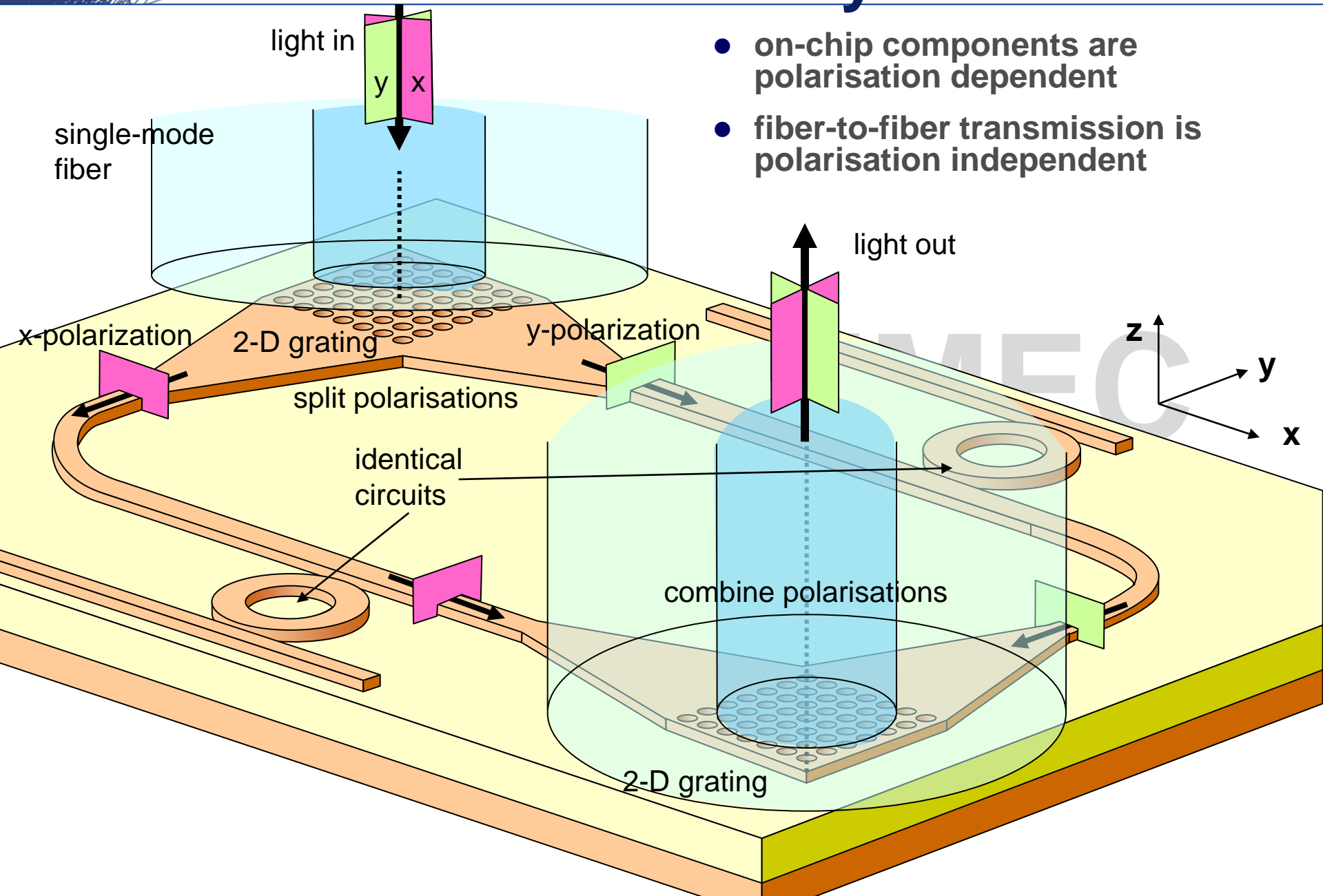

Polarization diversity circuit

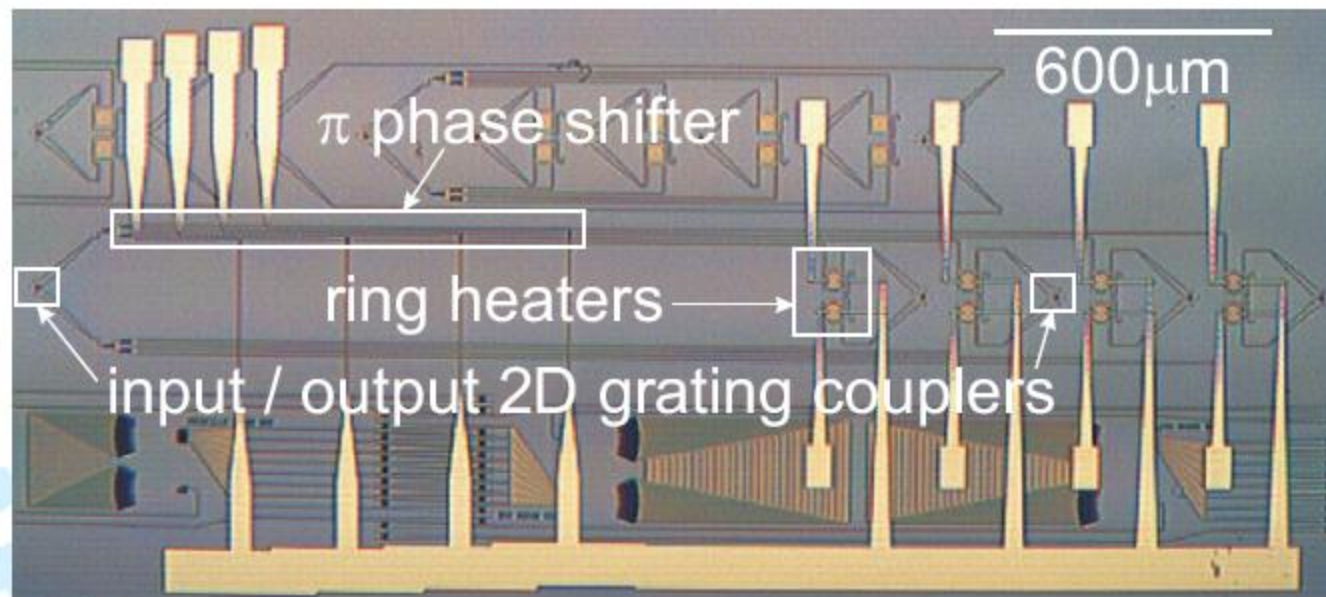
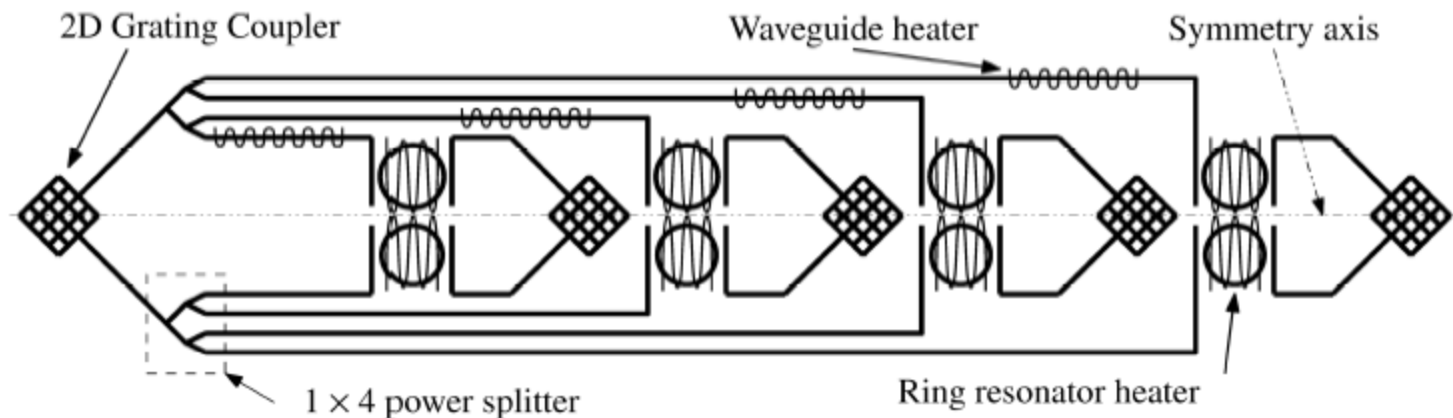

See Halir e.a. , OFC 2010, paper OWJ1

Increase efficiency standard coupler ?

Standard coupler (33%)

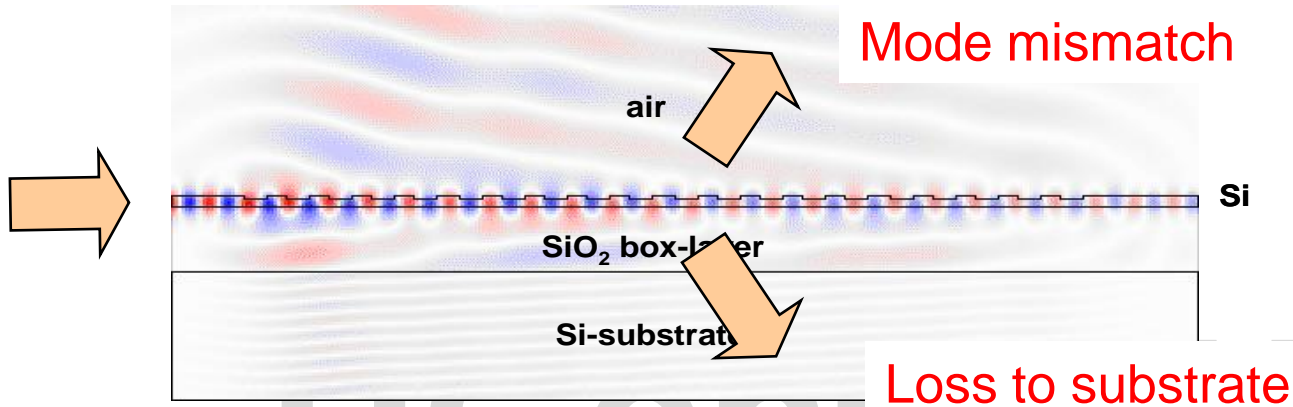

Improvement: add bottom mirror + apodize

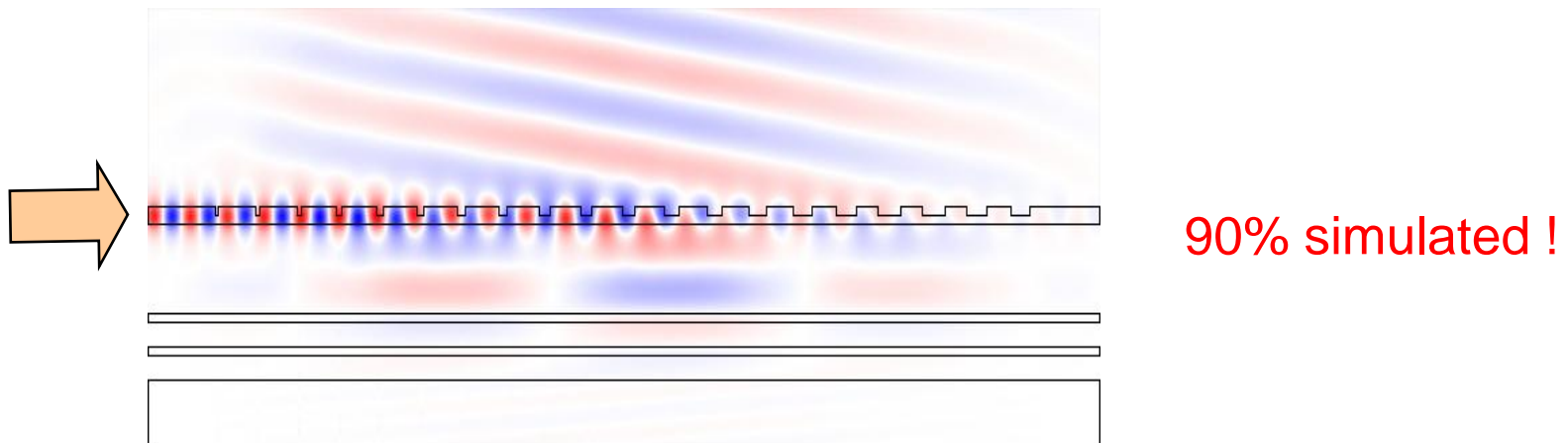

Gratings with bottom mirror

DBR bottom mirror

- Poly silicon DBR mirror
- a-Si waveguides

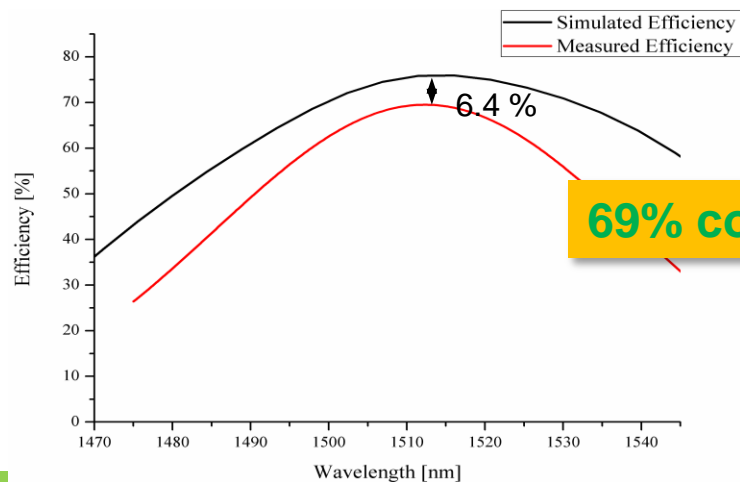
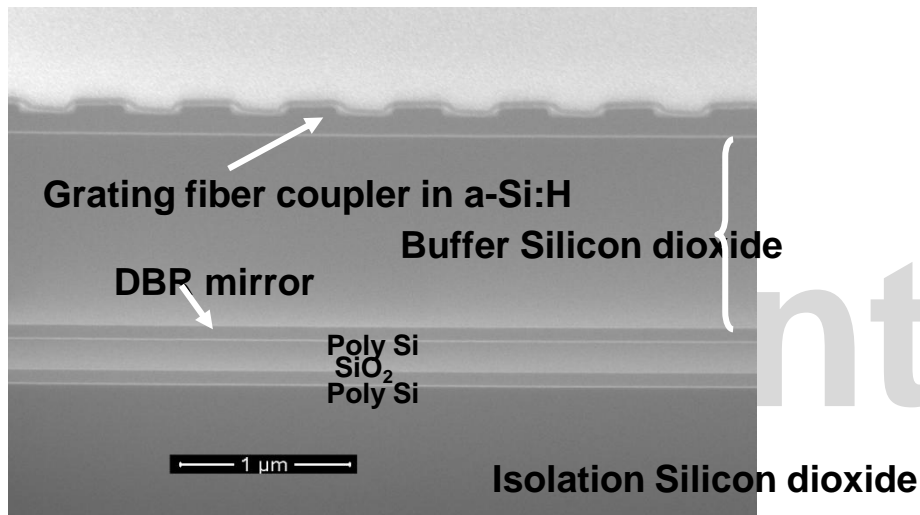

Selvaraja et al. CLEO/IQEC 2009

Gold bottom mirror

- Use waferbonding
- c-Si waveguides

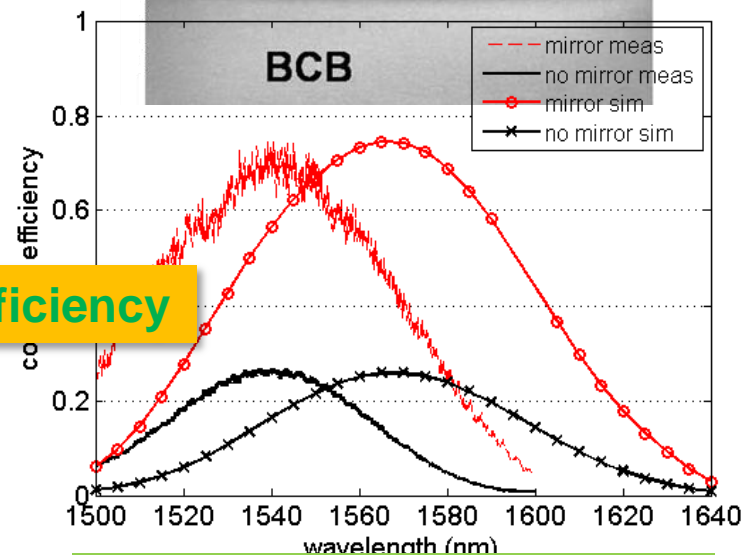
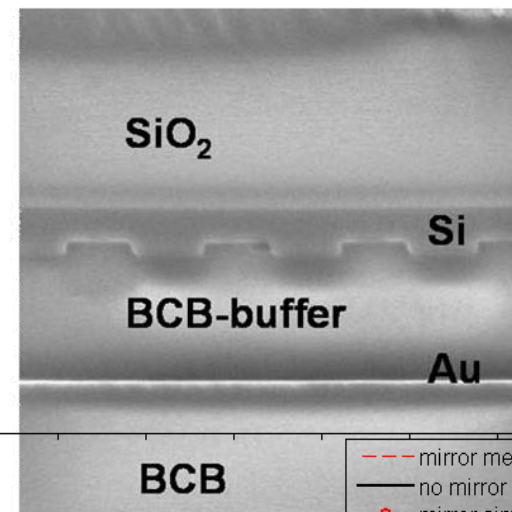

Van Laere et al., JLT 25(1), p.151 (2007)

Overlay gratings

Break top-bottom symmetry

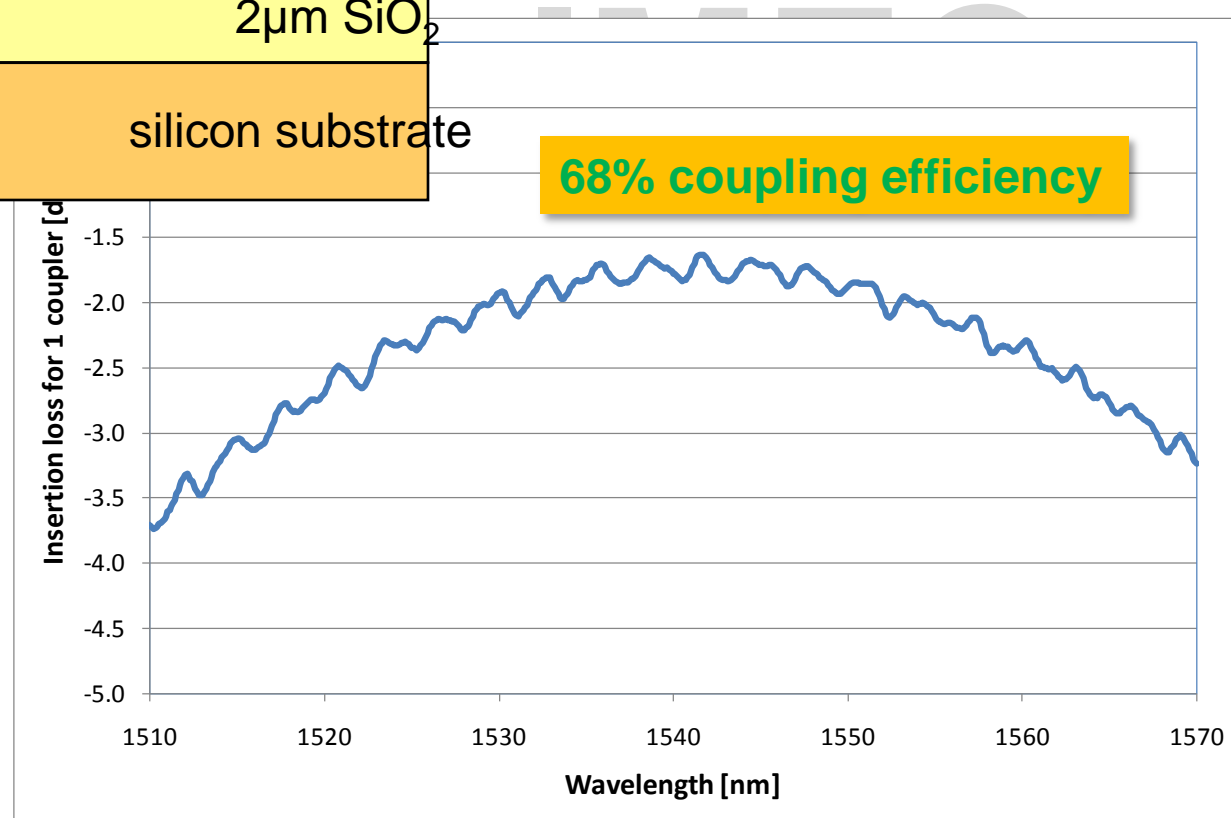
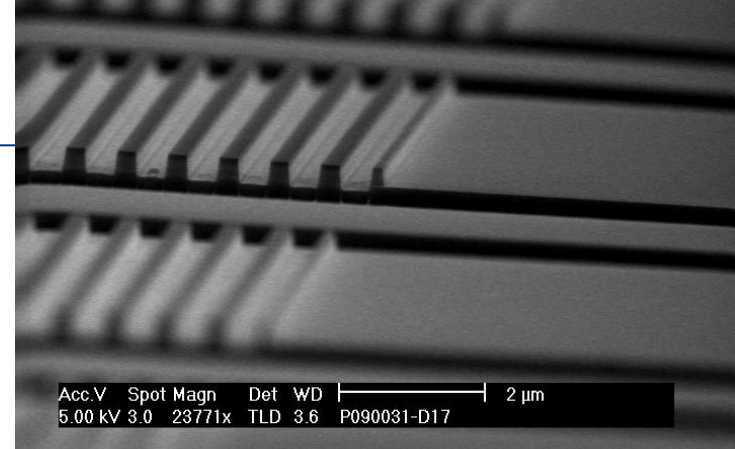
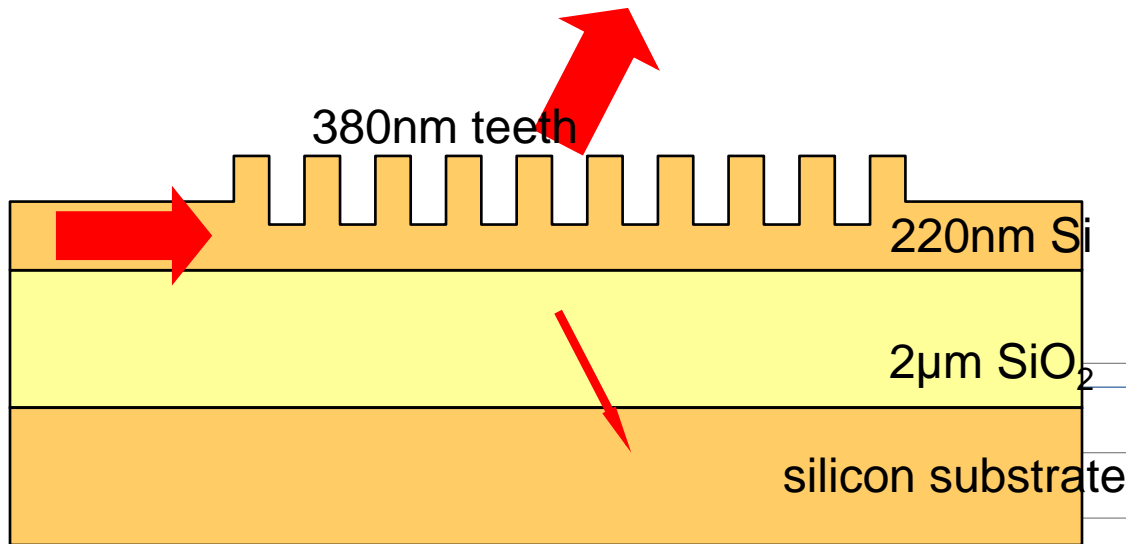

Grating zoo

Focusing grating

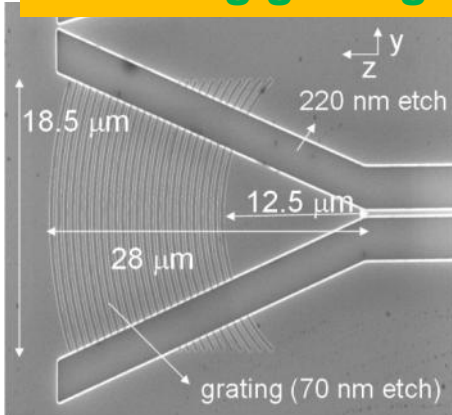

F. Van Laere, PTL 19, p. 1919 (2006)

Metal gratings

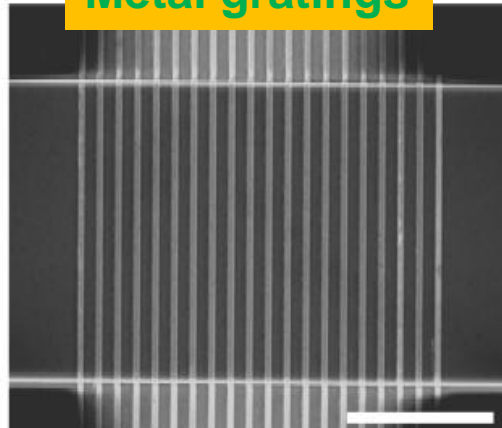

Scheerlinck, APL 92 p.031104 (2008)

Polymer wedge for vertical coupling

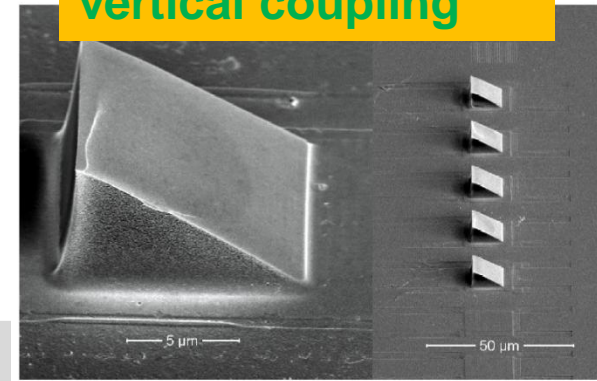

Schrauwen e.a. Phot. West, 7218, , p.72180B (2009)

Photonic crystal grating for low reflection deep etch

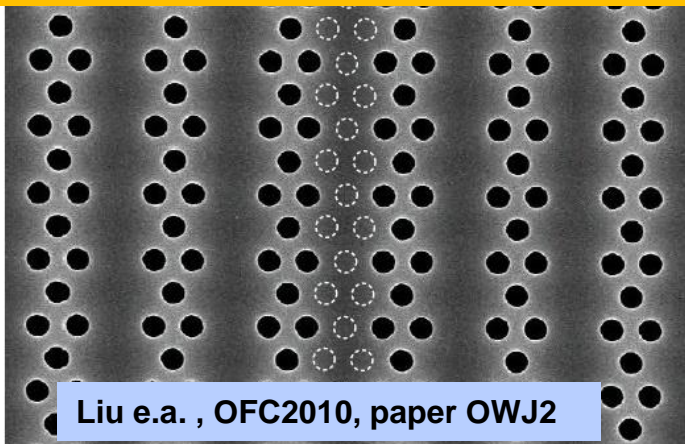

Liu e.a. , OFC2010, paper OWJ2

Apodized grating

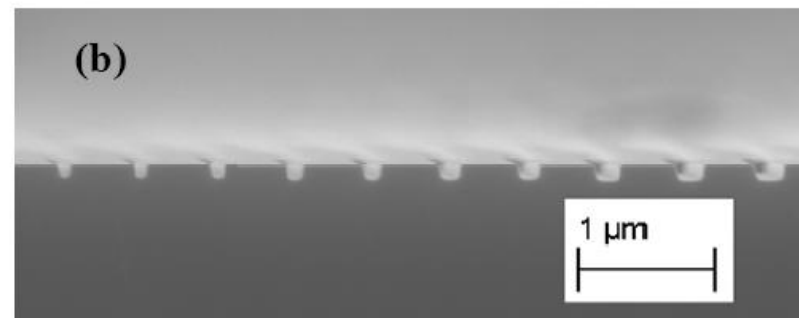

Tang e.a. , OFC2010, paper OWJ6

TE/TM interaction

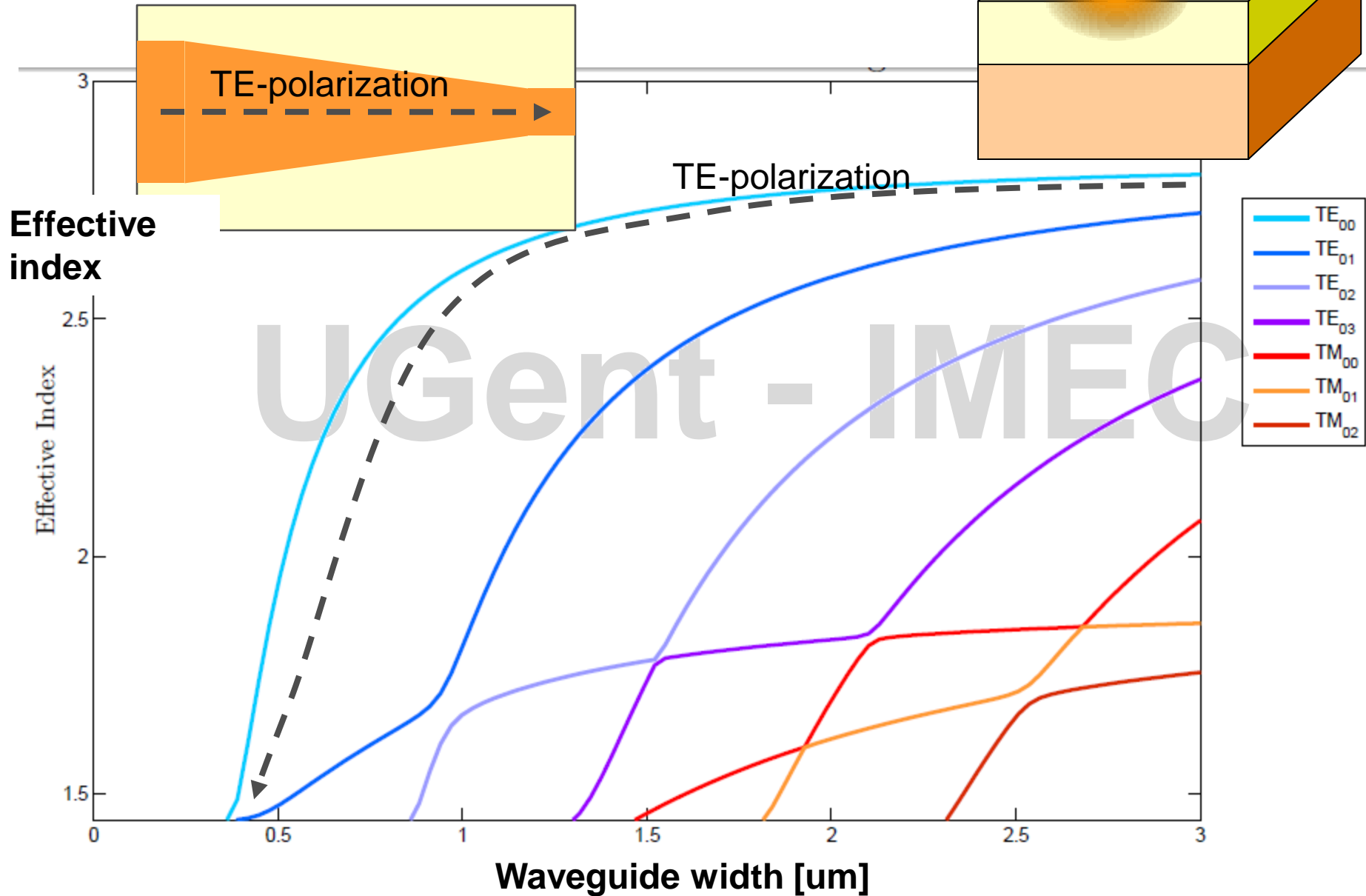

TE/TM interaction

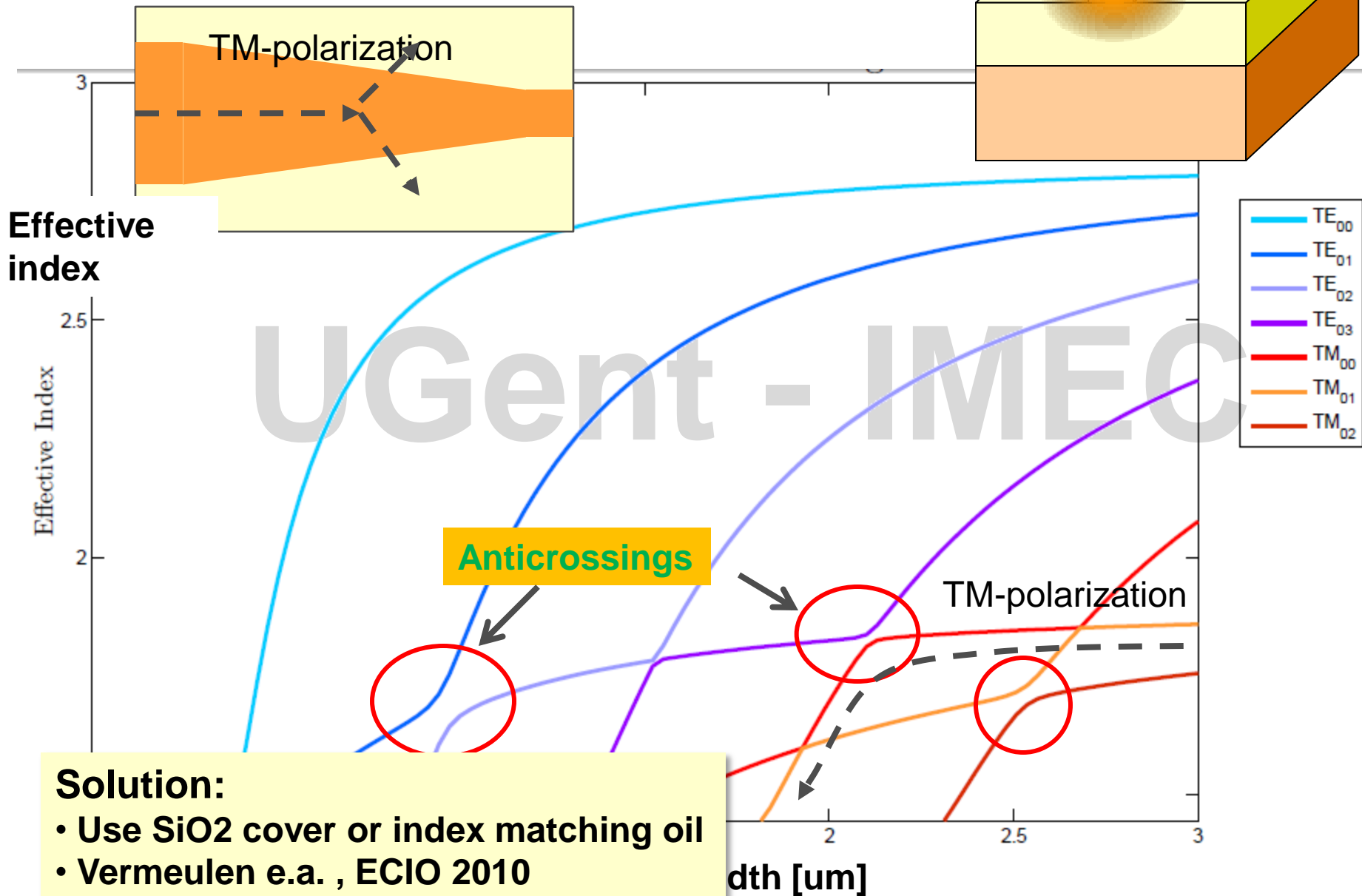

What we did not cover in passives

- **Details of fabrication** S.K. Selvaraja, JLT 27, p.4070 (2009)
- **Special waveguides**
 - Slot waveguides
 - Photonic crystal waveguides
- **Non linearities**
 - Interesting science
 - But also: big headache
- **And much more ...**

Ugent - IMEC

Outline

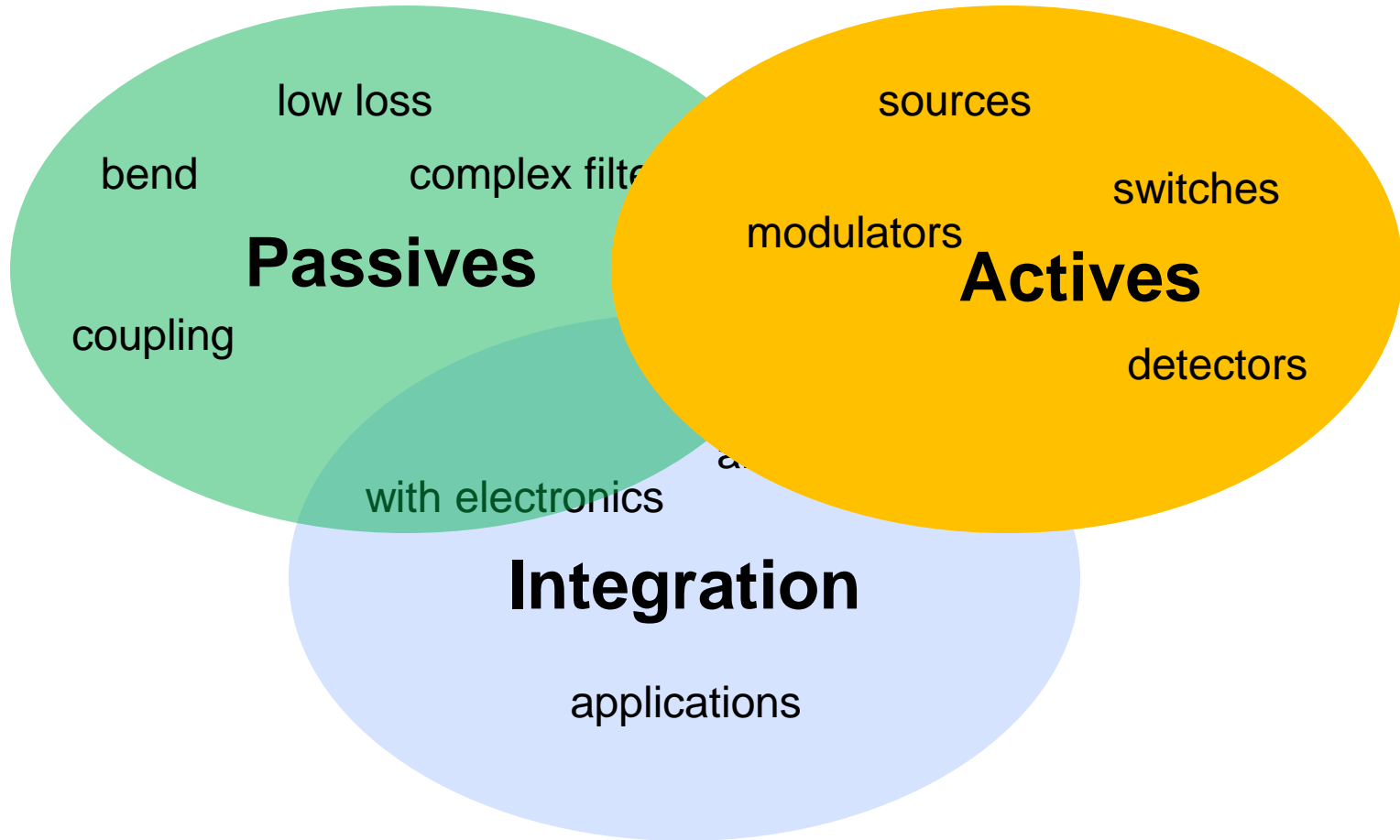

Outline

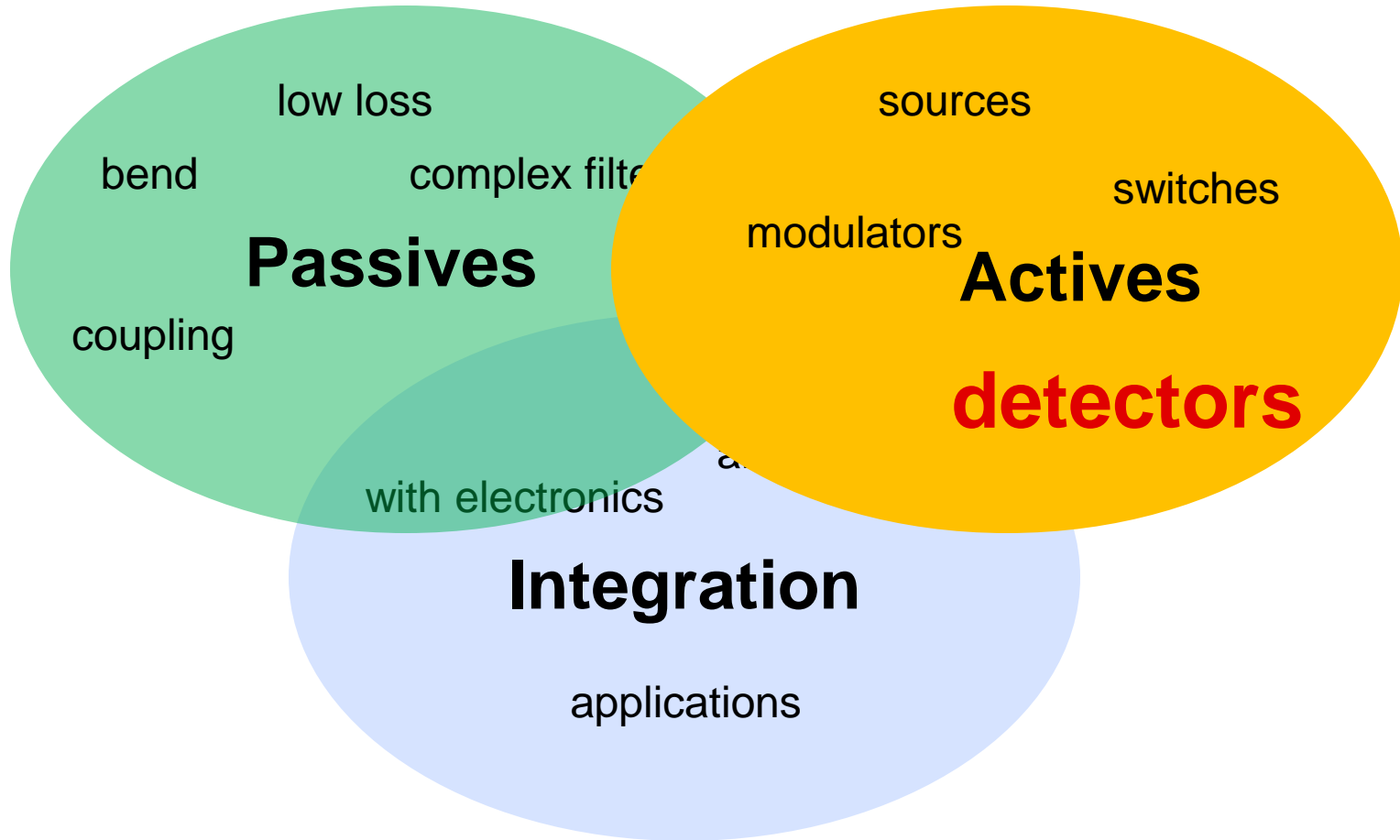

Detector

1. Hybrid integration

- Prefabricated diode,
- E.g. flip-chip on top of grating coupler
- Cost effective for low density, medium speed

UGent - IMEC

Detector

1. Hybrid integration

2. Heterogeneous integration through waferbonding

- See next section
- Example: 33GHz, 0.45A/W

Binetti e.a., EU PICMOS project

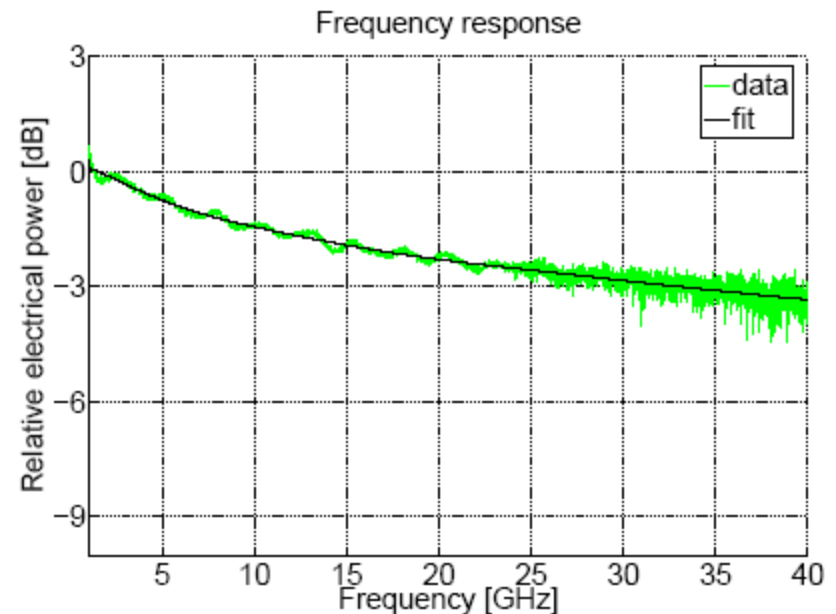
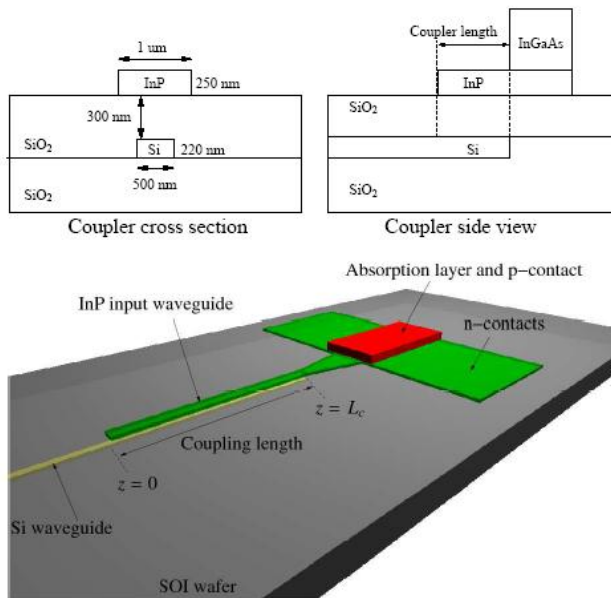

Detector

1. Hybrid integration
2. Heterogeneous integration through waferbonding
3. Implanted silicon, silicides ...

- Low efficiency + ~~slow~~ Kotura Talk, OFC2010, Monday
- Easy to process
- Useful monitor

UGent - IMEC

Detector

1. Hybrid integration
2. Heterogeneous integration through waferbonding
3. Implanted silicon, silicides ...
4. Germanium

- Efficient absorber up to 1600nm
- Large lattice mismatch (~4%). How to integrate ?
 - ☹ Buffer layer ? Requires 1-10um : Too thick !!
 - 😊 Two step growth process
 - 😊 Rapid melt growth

(Due to strain!)

UGent - IMEC

Ge-epitaxy

Two-step growth process:

- Direct growth of Ge on Si at low temperature ($\sim 350^\circ$) CVD
 - Thin (a few 10nm) highly-dislocated Ge layer
- Growth of thick Ge layer (few 100nm) at high temperature ($\sim 600^\circ$)
 - High quality Ge absorbing layer
- Thermal annealing to reduce the dislocation density

Using MBE, UHV-CVD, RP-CVD ...

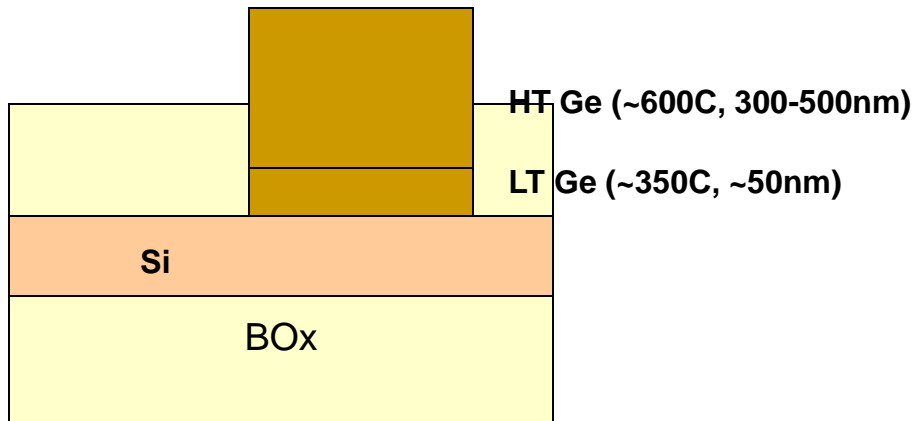

Ge-epitaxy

Two-step growth process:

- Direct growth of Ge on Si at low temperature ($\sim 350^\circ$) CVD
 - Thin (a few 10nm) highly-dislocated Ge layer
- Growth of thick Ge layer (few 100nm) at high temperature ($\sim 600^\circ$)
 - High quality Ge absorbing layer
- Thermal annealing to reduce the dislocation density

Using MBE, UHV-CVD, RP-CVD ...

Different integration approaches:

Butt Coupling

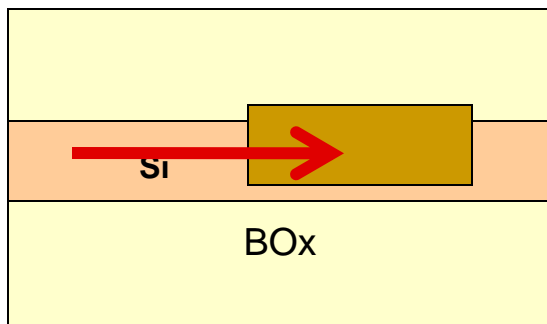

Evanescent Coupling

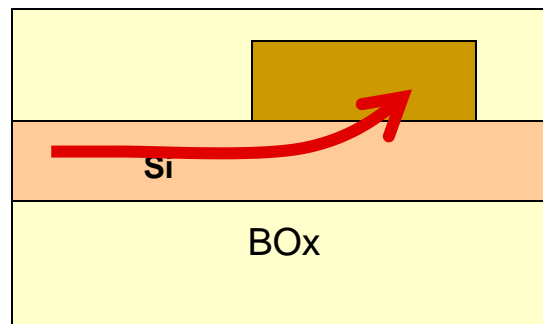

Two level

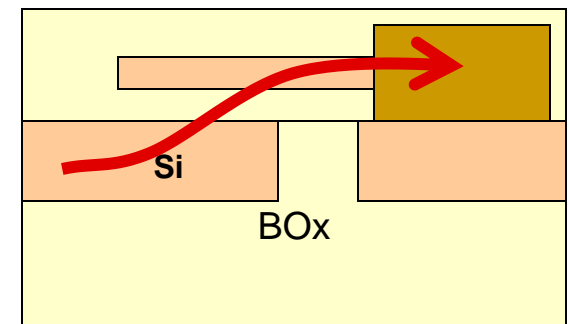

Ge-detector

Two step growth – butt coupling

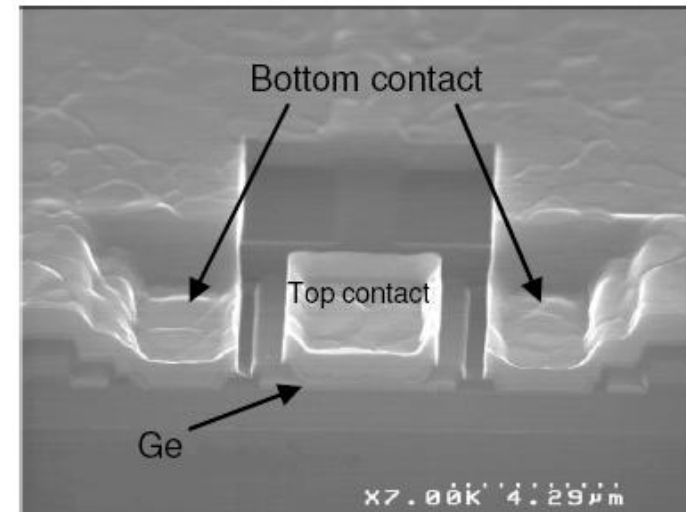
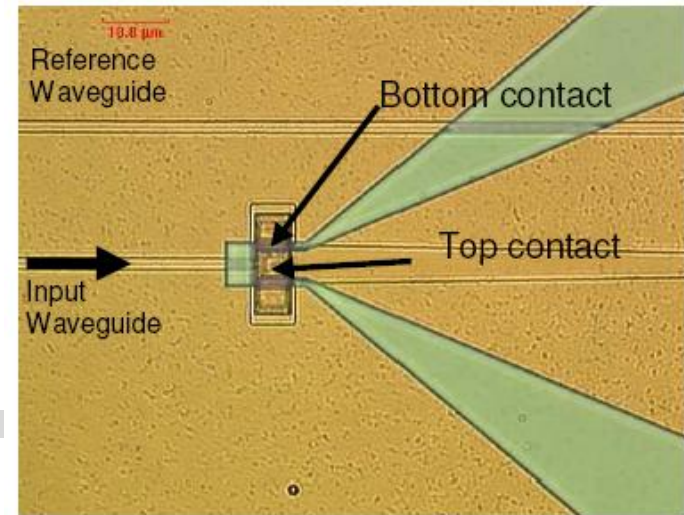
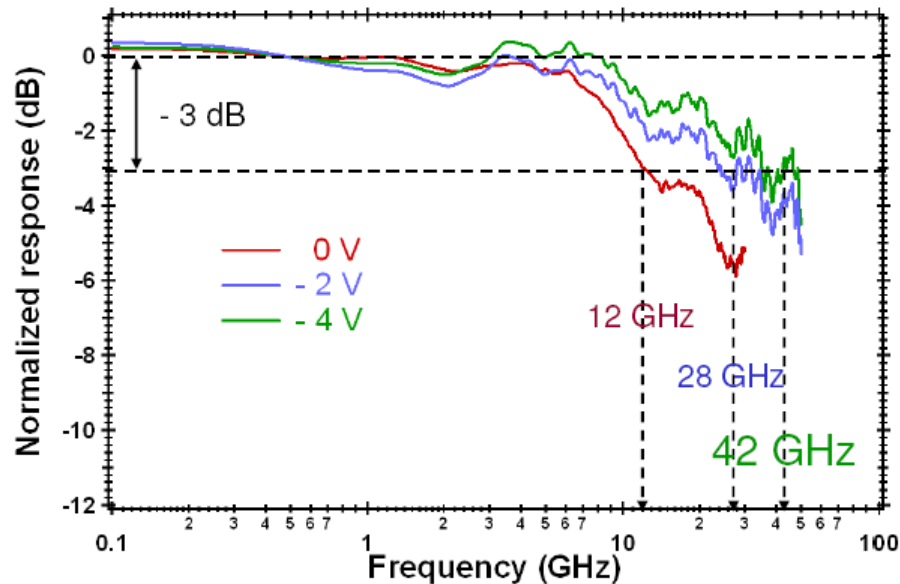
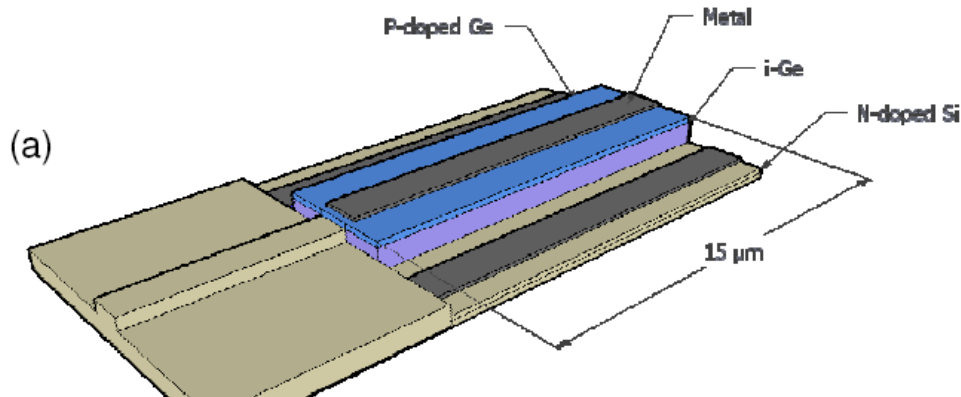

Ge-detector

Rapid melt growth

1. Ge CVD deposition on SiON mask with small opening
2. Encapsulation
3. RTA induces melt + recrystallisation to single crystal

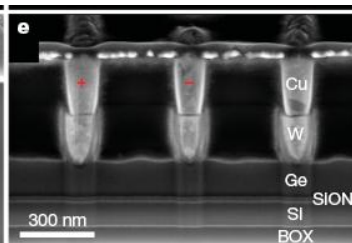
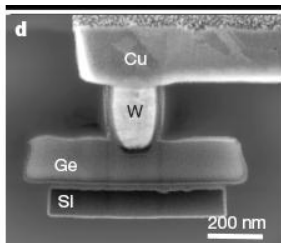
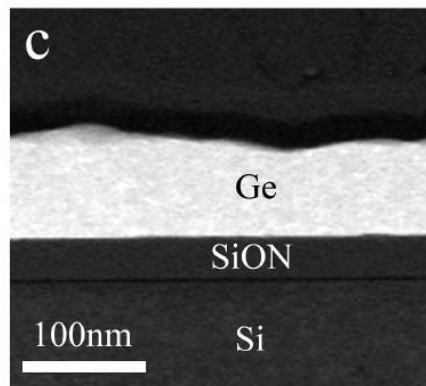
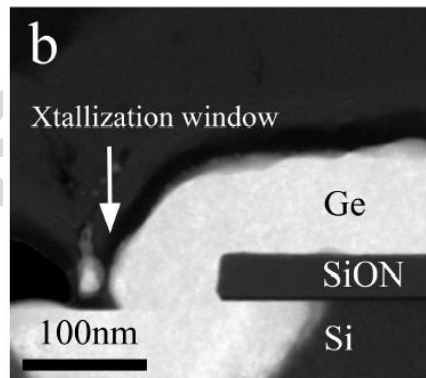
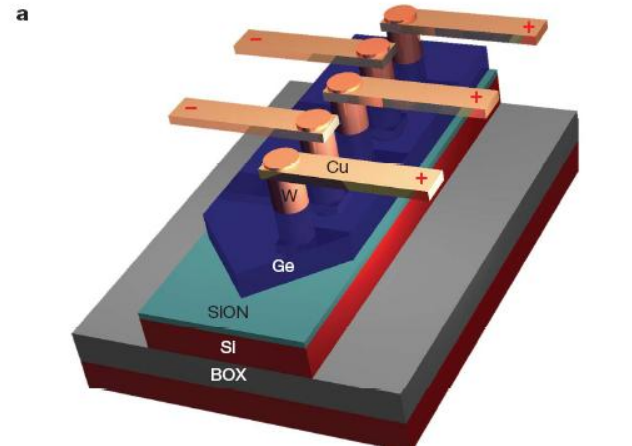

IMEC

Assefa e.a. , OE 18, pp4997 (2010)
Assefa e.a. , Nature (2010)

Ge-detector

Rapid melt growth: results

- 40GB/s operation as PD
- APD operation with
 - 10dB gain at low bias !!
 - >30GHz bandwidth

Assefa e.a. , OE 18, pp4997 (2010)
Assefa e.a. , Nature (2010)

a

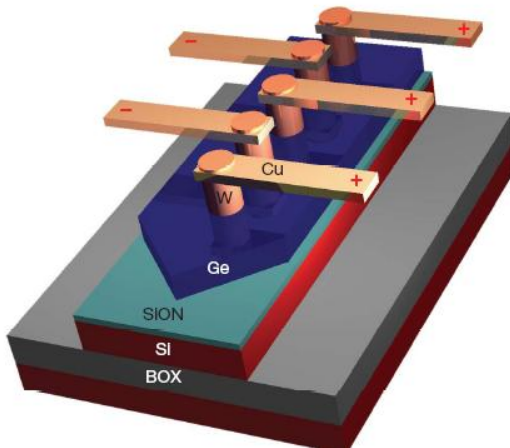

er

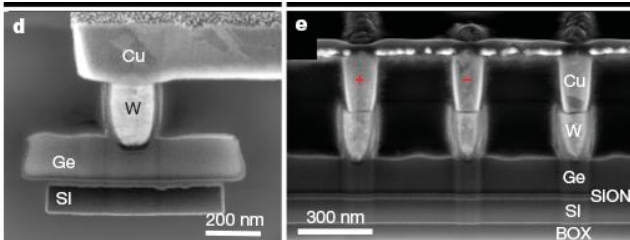
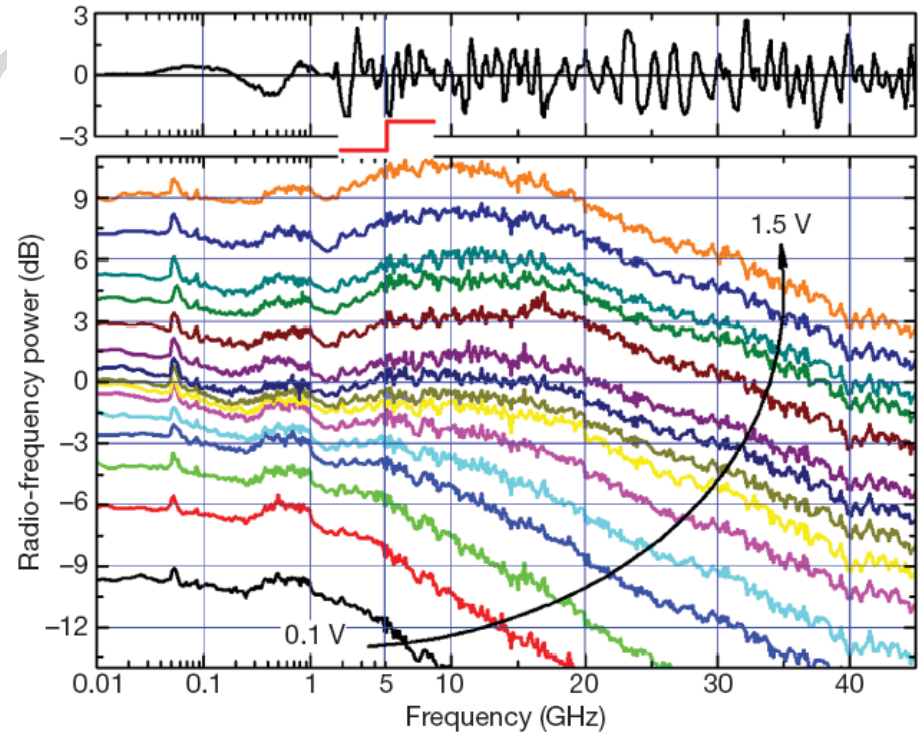

Detector – state-of-the-art

Ge-on-Si photodetectors

III-V-on-Si photodetectors



	 LUXTERA	 MIT	 INTEL	 UPS-IEF & LETI	 UPS-IEF & LETI	 EU- PICMOS project	 INTEL	 IMEC	 EU- PICMOS project
Year	~ 2007	2007	2007	2008	2009	2006	2007	2007-09	2009
structure	PIN	PIN	PIN	PIN	PIN	PIN	PIN	MSM	PIN
Dark current at -1V	~10 μ A	~1 μ A	~170 nA	~ 20 nA	~ 1 μ A	~1 nA	~50 nA	~1 nA	~1 nA
Responsivity	~ 0.85 A/W	~1.08 A/W	~0.9 A/W	~ 1 A/W	~0.8 A/W	~0.45 A/W	~0.31 A/W	~1 A/W	~0.7 A/W
Bandwidth	20 GHz	7.2 GHz	31 GHz	42 GHz	~ 90 GHz	33 GHz	0.5 GHz	-	25 GHz

Table compiled by L. Vivien e.a. (IEF) for EU HELIOS project

Extracted from D003 “Silicon Photonics State-of-the-Art”, public deliverable (<http://www.helios-project.eu/>)

Outline

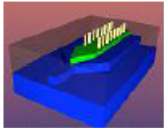
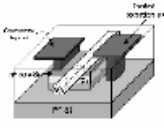
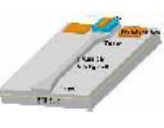

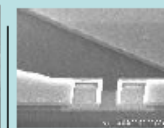
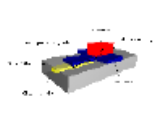
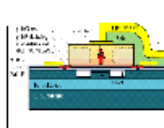
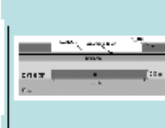
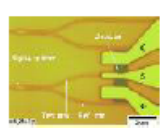
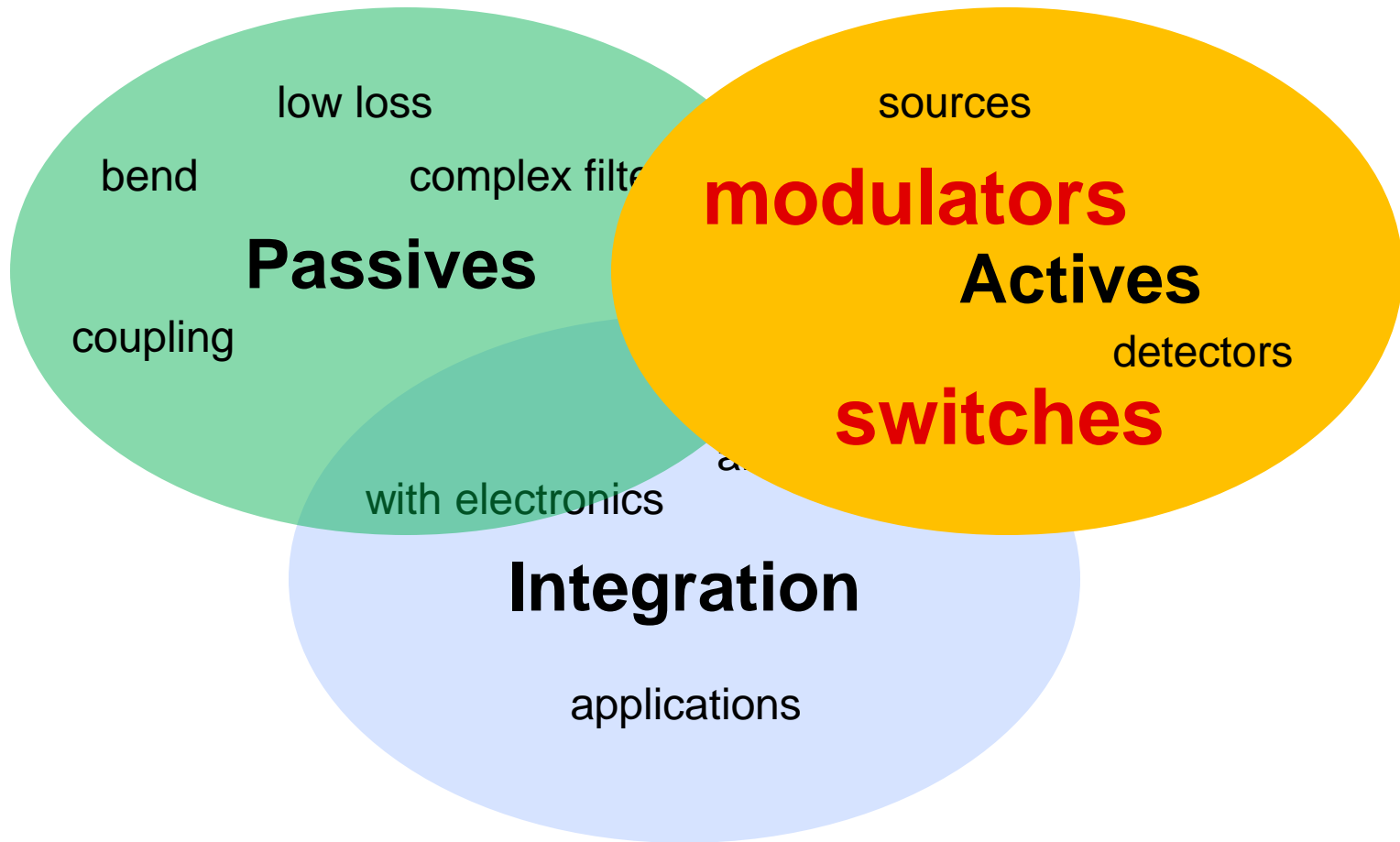
Modulation of light

How to make a modulator in silicon

- Silicon has no intrinsic EO-effect
- But:
 - Free carriers induce absorption
 - And index modulation ...

Plasma dispersion effect

Empiric relations determined

Soref, JQE 23, (1987).

$$\Delta n = -8,8 \cdot 10^{-22} \Delta N - 8,5 \cdot 10^{-18} \Delta P^{0,8}$$

$$\Delta \alpha = 8,5 \cdot 10^{-18} \Delta N + 6,0 \cdot 10^{-18} \Delta P$$

(in silicon at 1550nm – carrier densities in cm⁻³)

Change carrier densities by

- Doping
- Injection/extraction of carriers

Injection vs. depletion

Carrier injection

- p-i-n diode in forward bias
- Inject carriers into waveguides
- Strong effect (many carriers)
- Slow effect (~1GHz)

Carrier depletion

- p-n diode in reverse bias
- Extract carriers from waveguide
- Weaker effect
- Fast effect (>40GHz)

Carrier accumulation

- Accumulation at oxide
- Similar to capacitor
- Fast

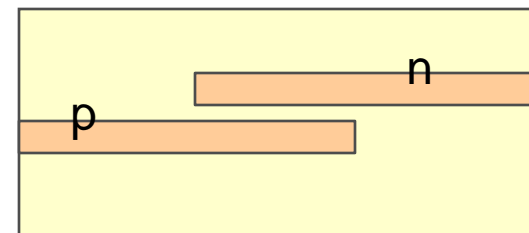
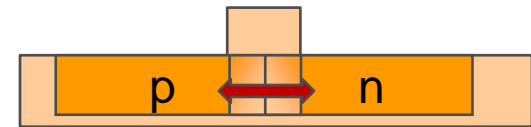
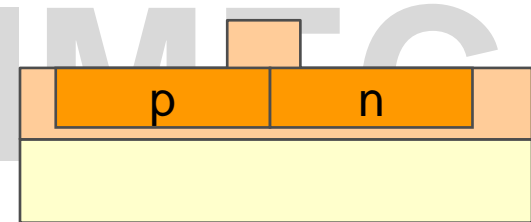
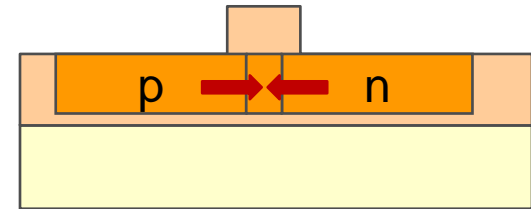
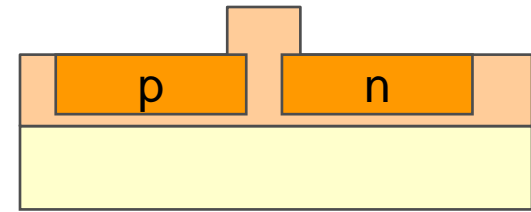

Injection Modulator



100-200 μm length

p-i-n diode

MZI configuration

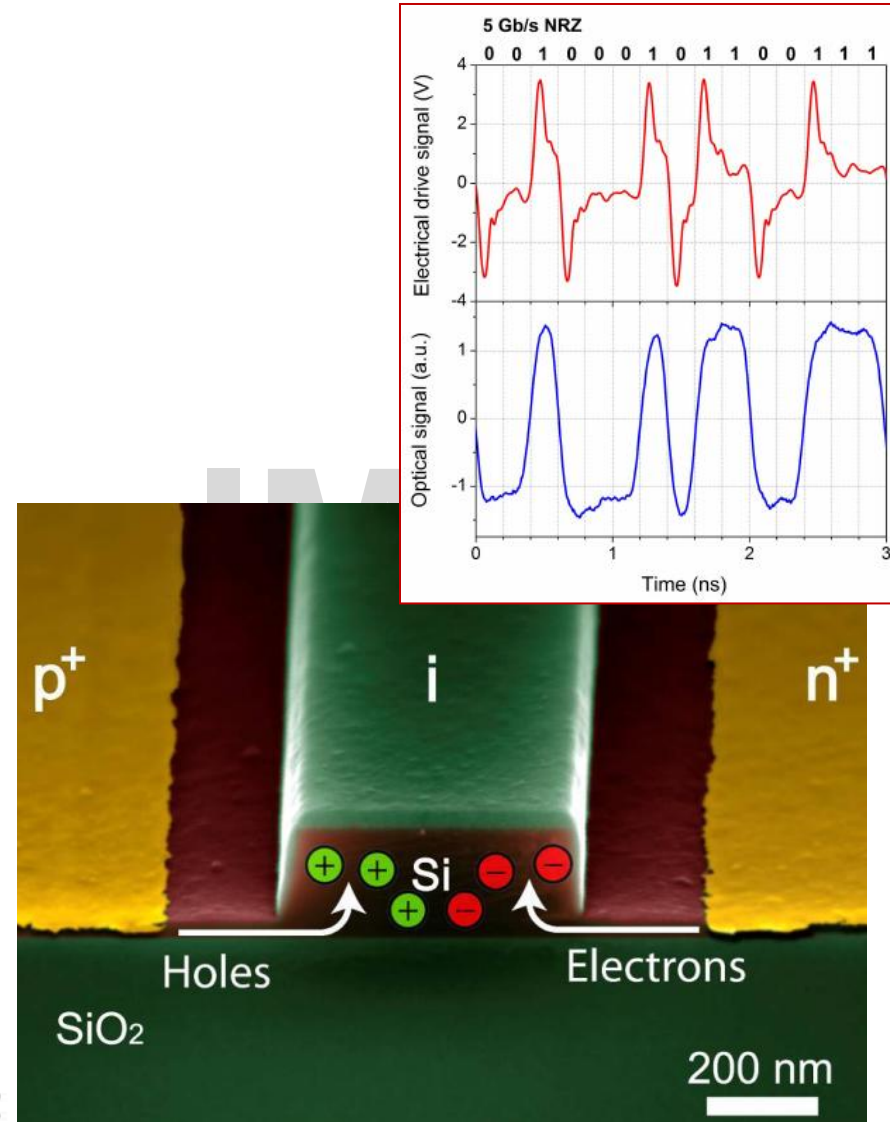
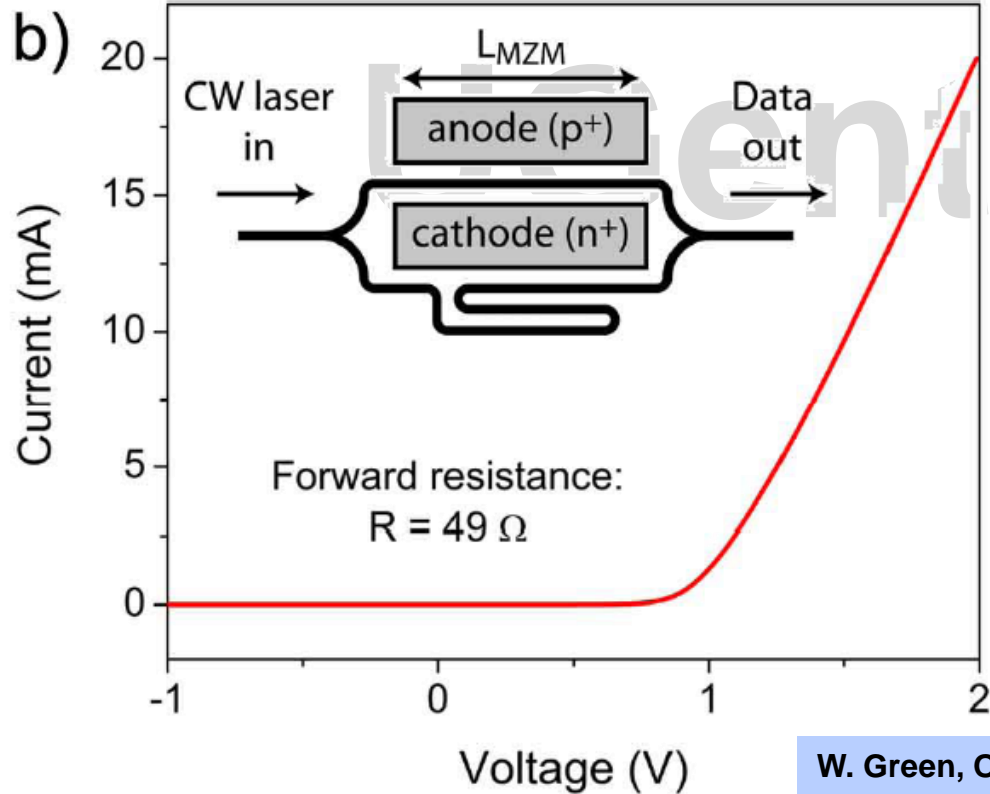

Ring Modulator

Speed ~2GB/s

With preemphasis: >20GB/s

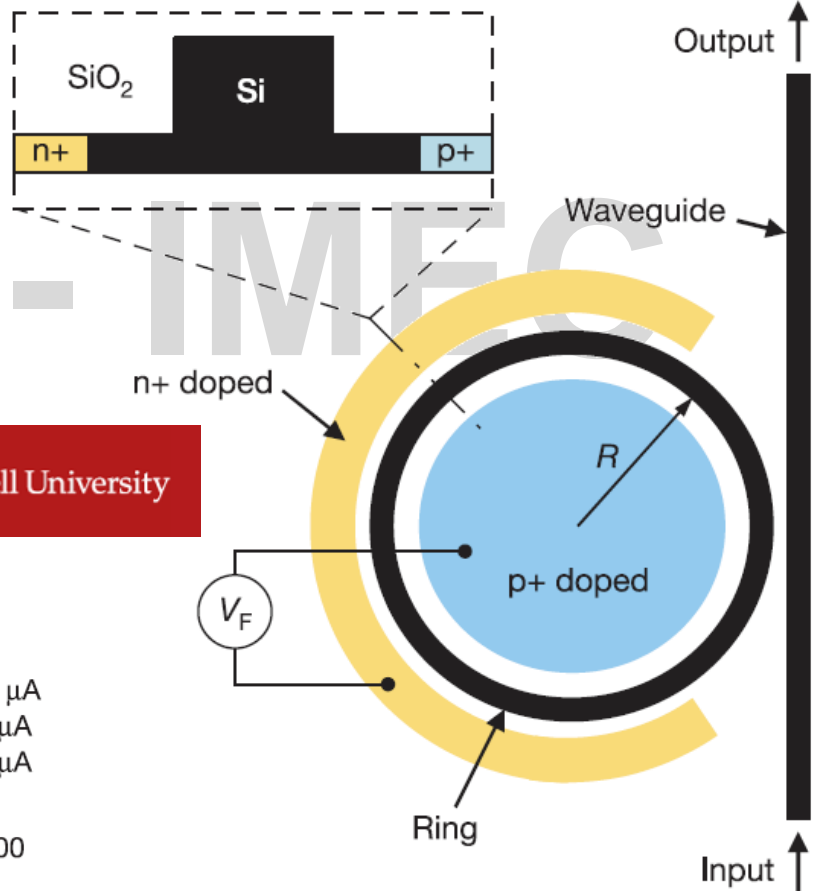
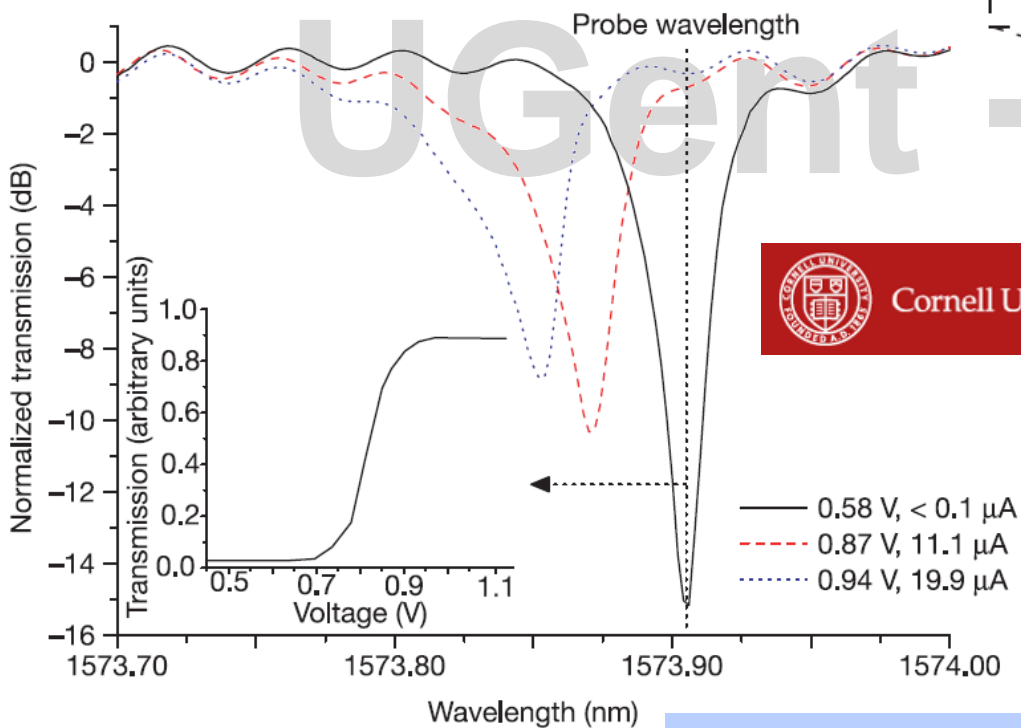
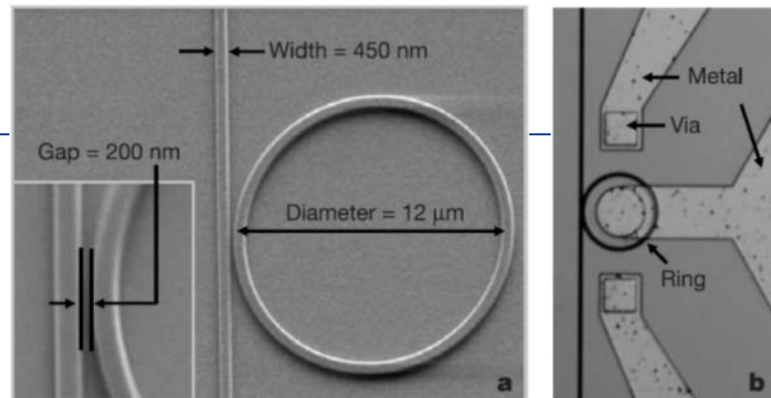

Q. Xu et al, nature 435(19), p03569 (2005)

Example: depletion modulator



Complex multi-doping profile

- Larger index change
- Lower RC

But

- Still a long device (4mm)
- Requires travelling wave electrodes ?

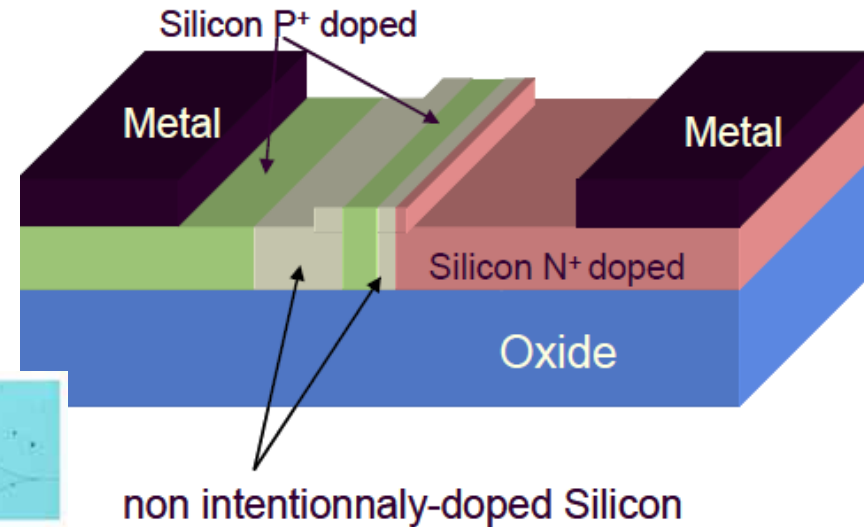
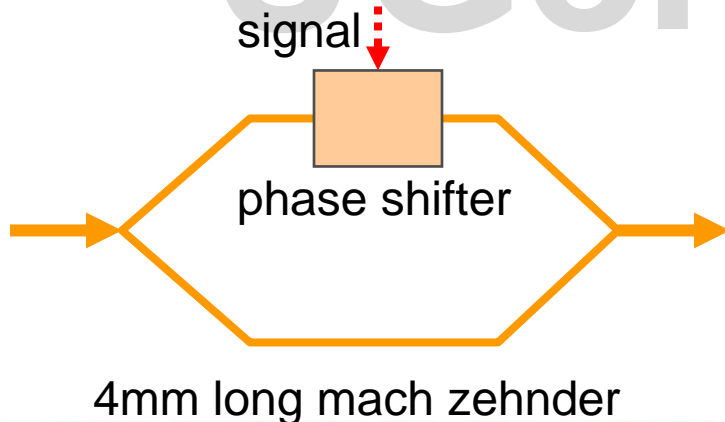
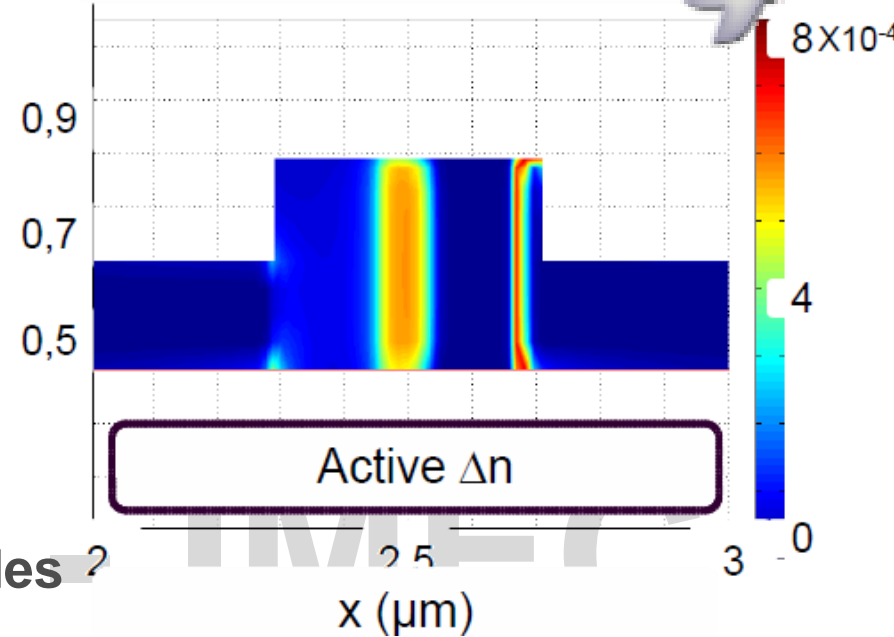

Ring modulator

Ring resonator in p-i-n junction

- Carrier injection
- Change refractive index
- Change resonance

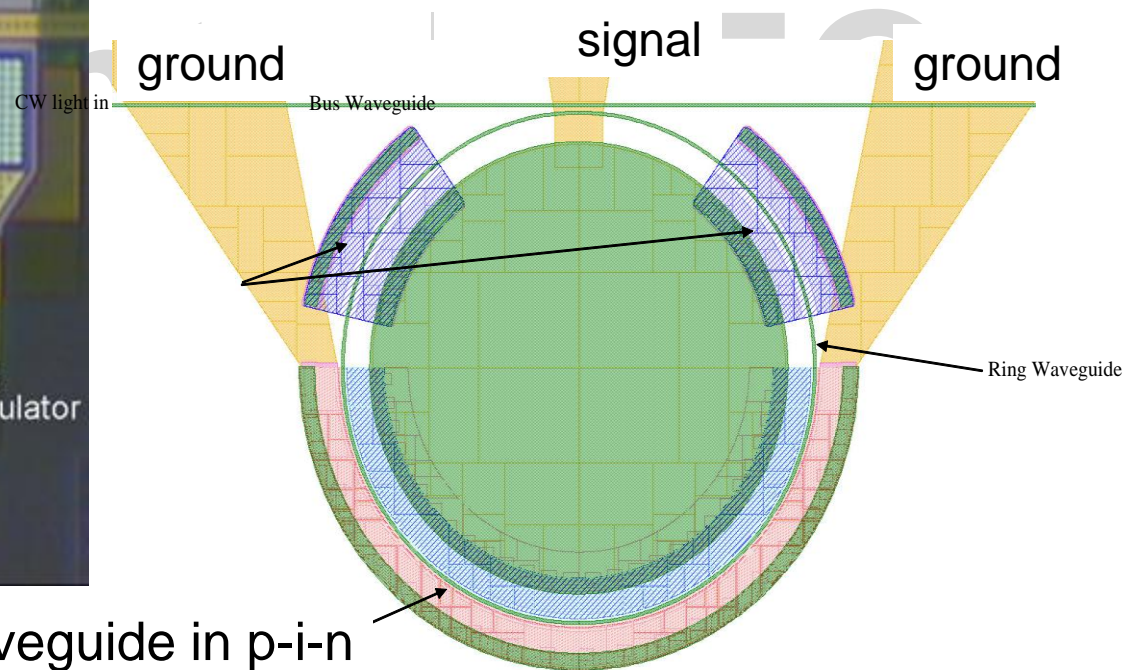
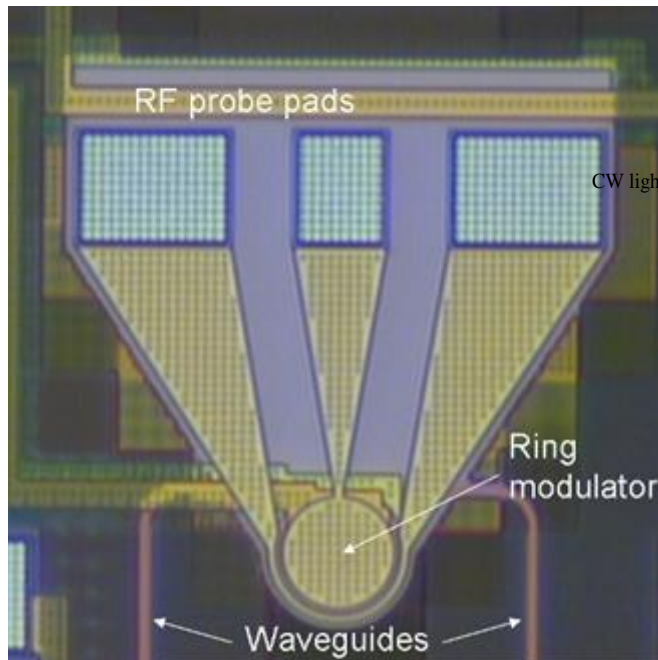
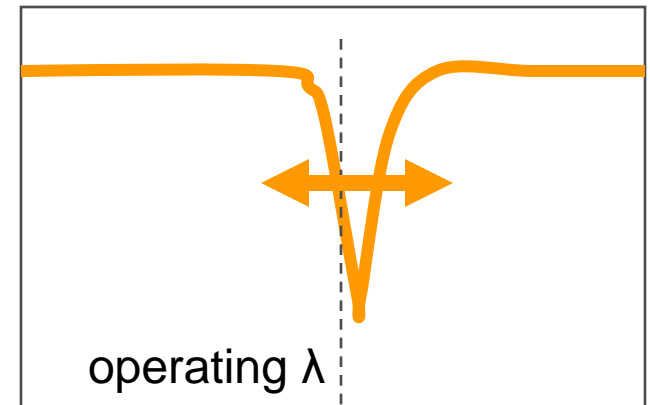

SiGe electroabsorption modulator

Operation at 1550nm

Compact: 30 μ m

But: one operation point.

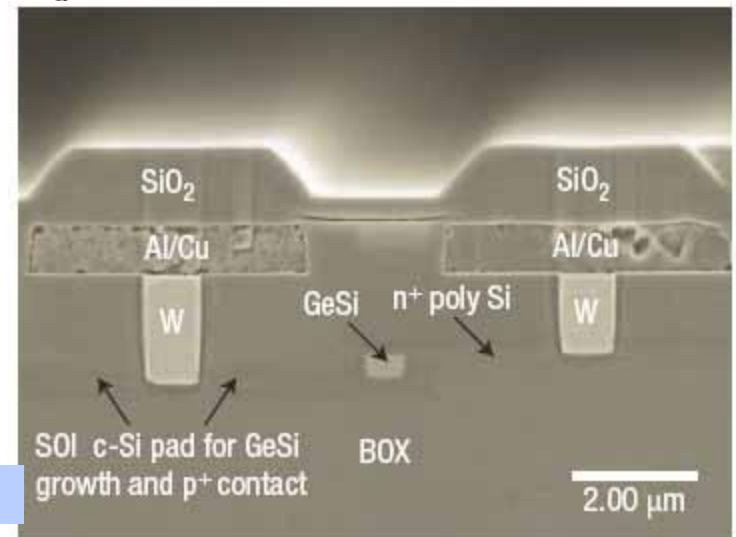
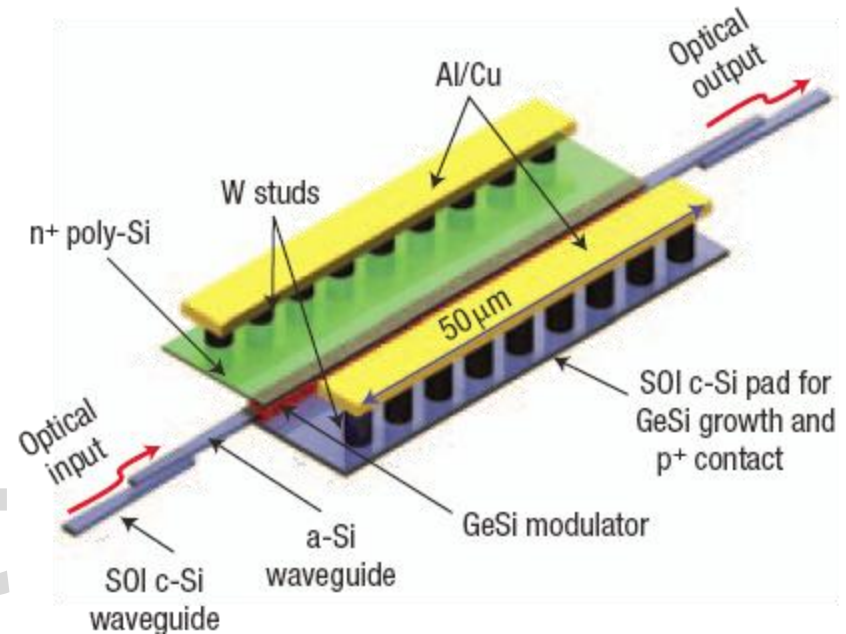
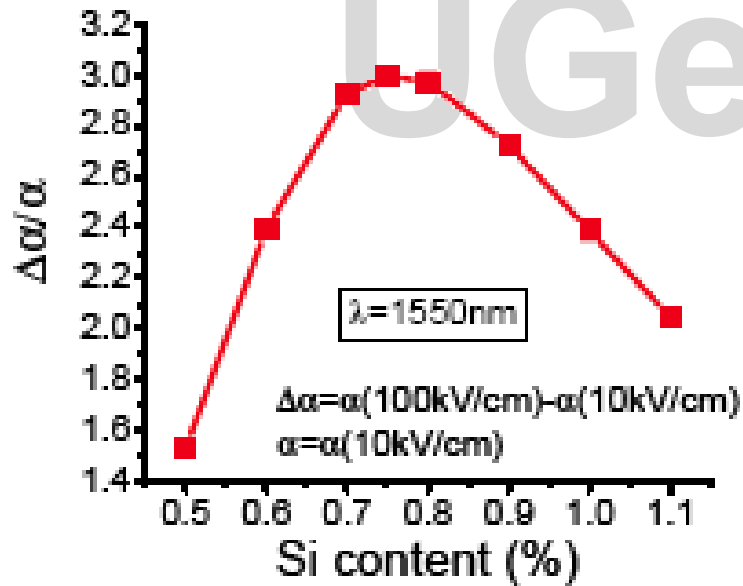

Outline

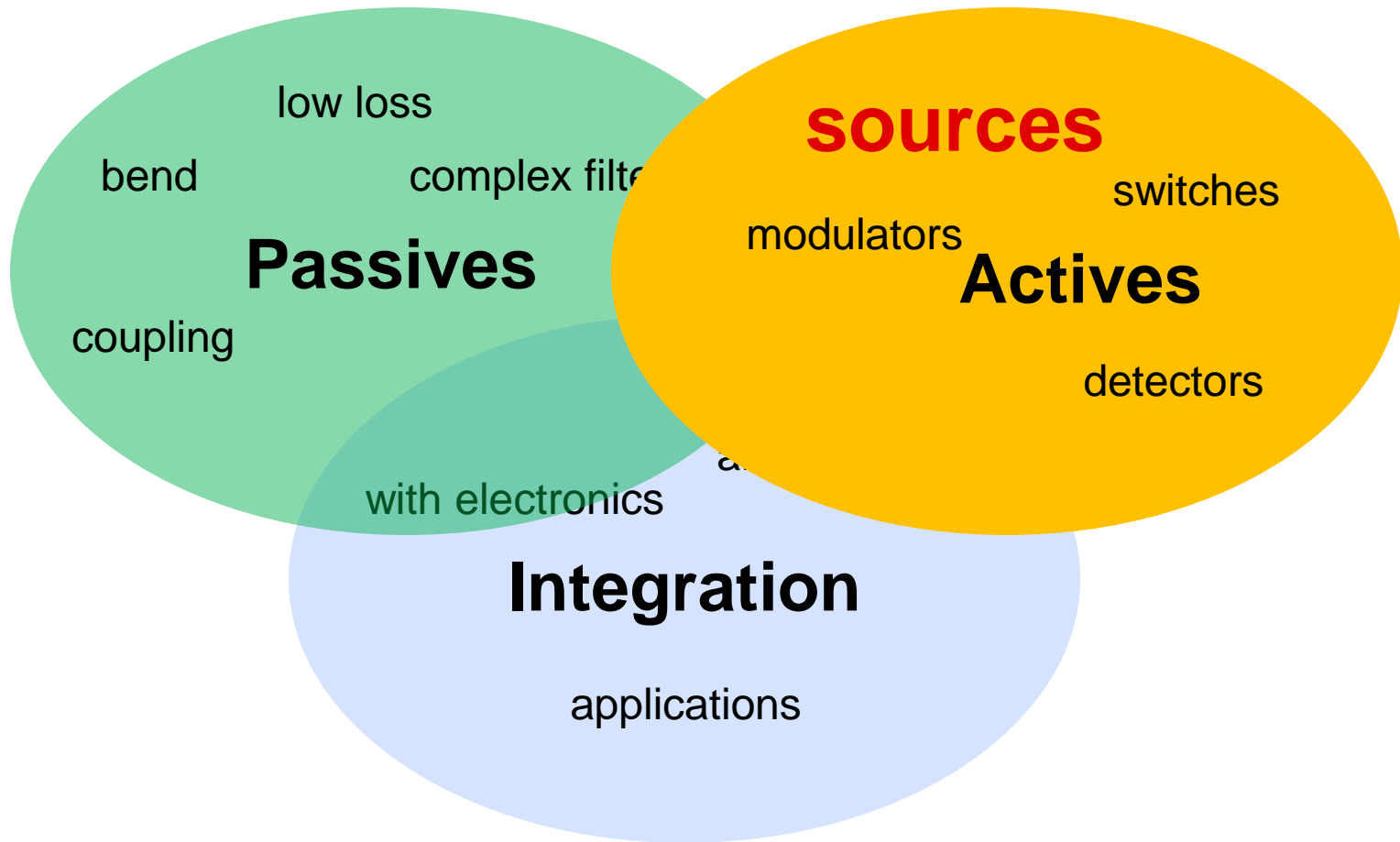

Sources on Silicon

1. Hybrid integration

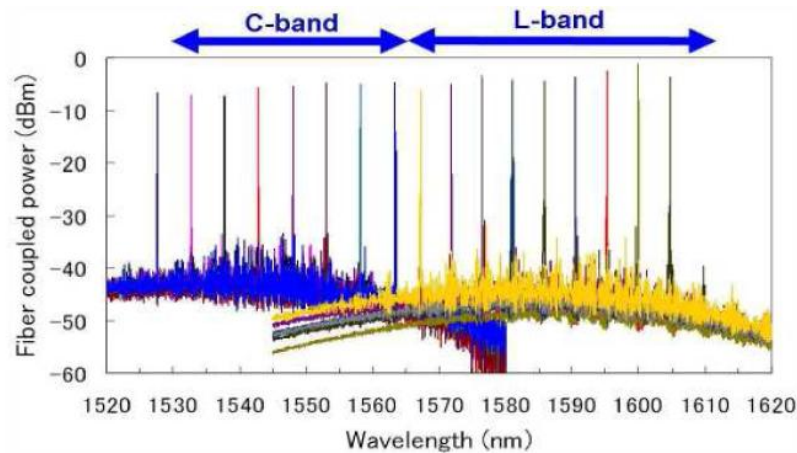
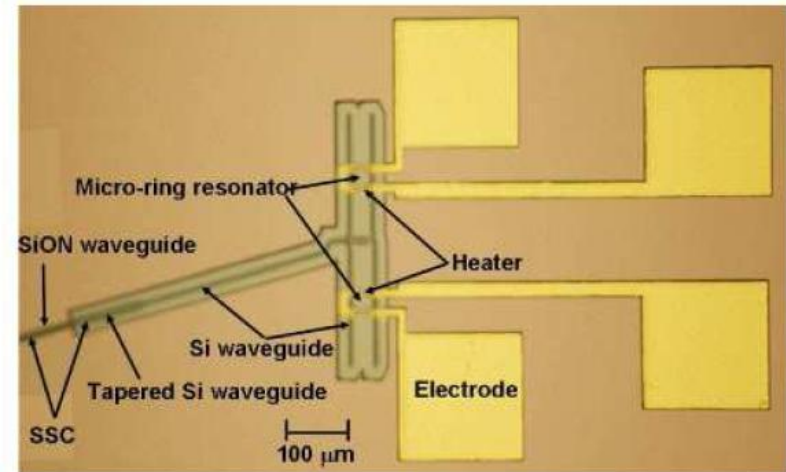
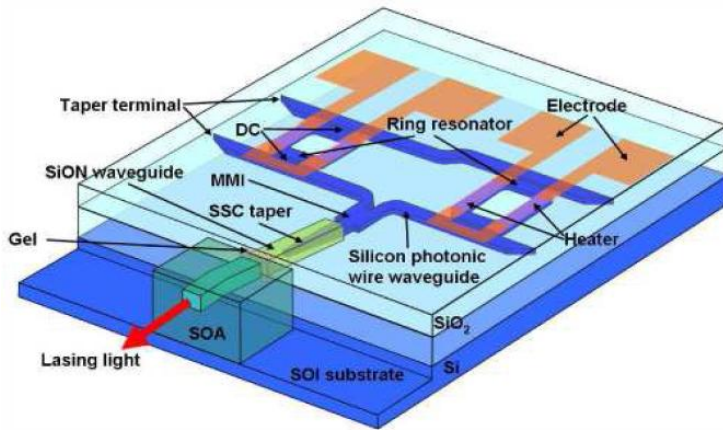

Song e.a. OE 17, 14063-14068 (2009).

Sources on Silicon

1. Hybrid integration
2. Monolithic integration

Strained Ge-laser

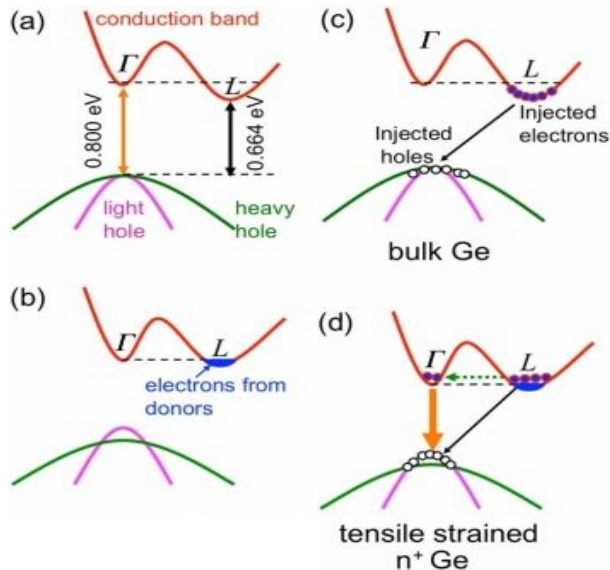

MIT press release

Er-doped Si nanocrystals

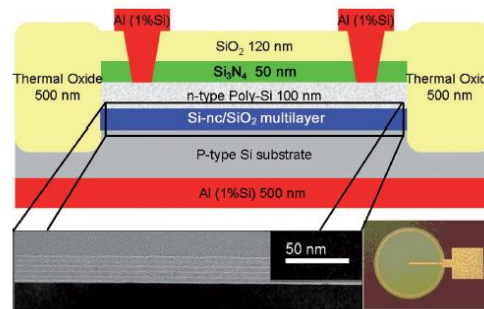

Zhizhong, Y. et al. Proc of the IEEE 97, 1250 (2009).

III-V on silicon epitaxy

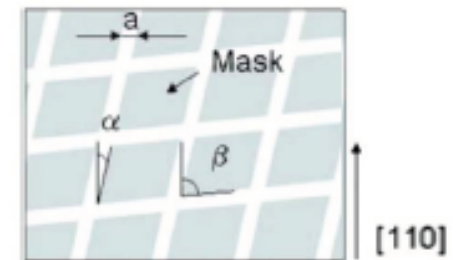

Junesand e.a., IPRM 2009 pp59

Sources on Silicon

1. Hybrid integration
2. Monolithic integration
3. Integration through waferbonding techniques

SOI-wafer

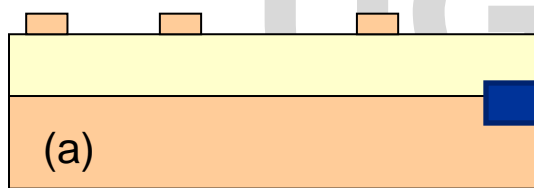

Planarization

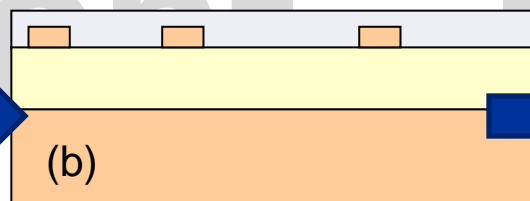

Bonding

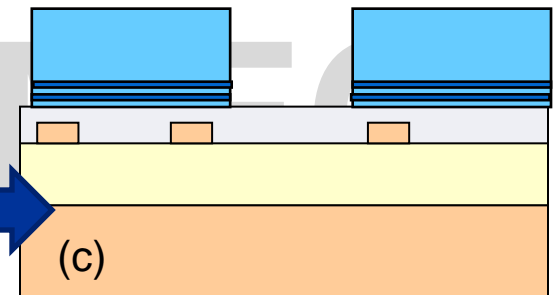

Substrate Removal

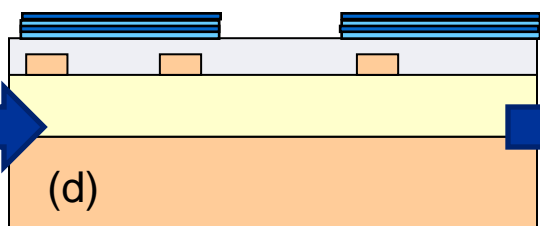

Pattern definition

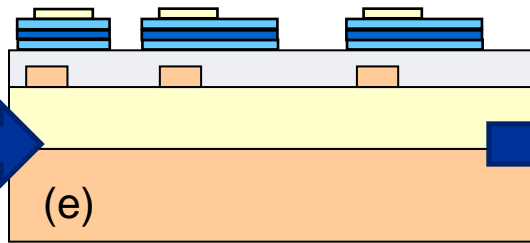

III-V processing

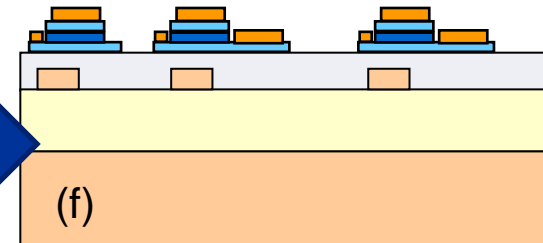

III-V/Silicon photonics

Bonding of III-V epitaxial layers

- Molecular die-to-wafer bonding, direct bonding
 - Based on van der Waals attraction between wafer surfaces
 - Requires “atomic contact” between both surfaces
 - very sensitive to **particles**
 - very sensitive to **roughness**
 - very sensitive to **contamination of surfaces**
- Adhesive die-to-wafer bonding
 - Uses an adhesive layer as a glue to stick both surfaces
 - Requirements are more relaxed compared to Molecular
 - glue **compensates** for particles (some)
 - glue **compensates** for roughness (all)
 - glue **allows** (some) contamination of surfaces

LETI,
UCSB+INTEL
...

IMEC/Ghent University

UGent - IMEC

Bonding Technology

Cross-sectional image of III-V/Silicon substrate

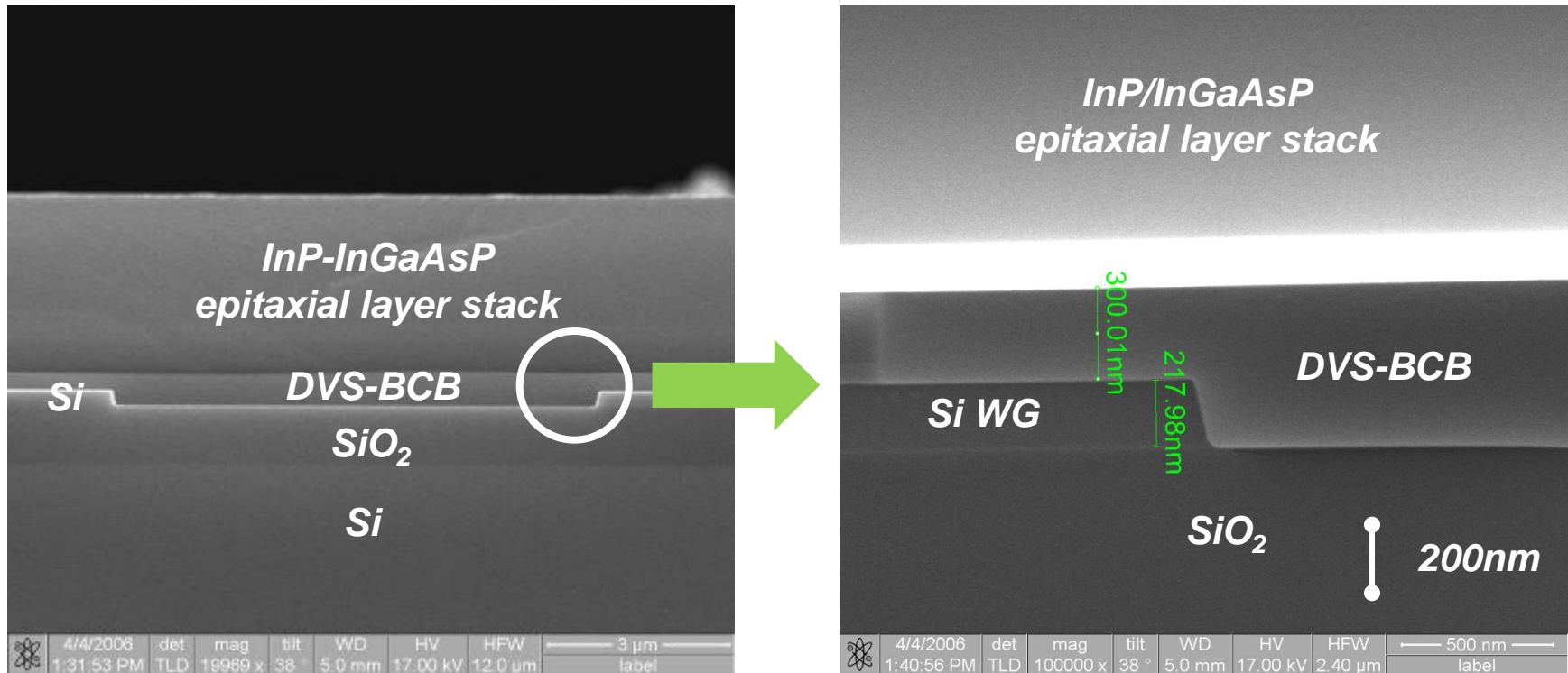

- 200nm bonding layer routinely and reliably obtained
- Recently : focus on **thin bonding** layer development (<100nm)

Business model ?

Option I : all CMOS-fab processing

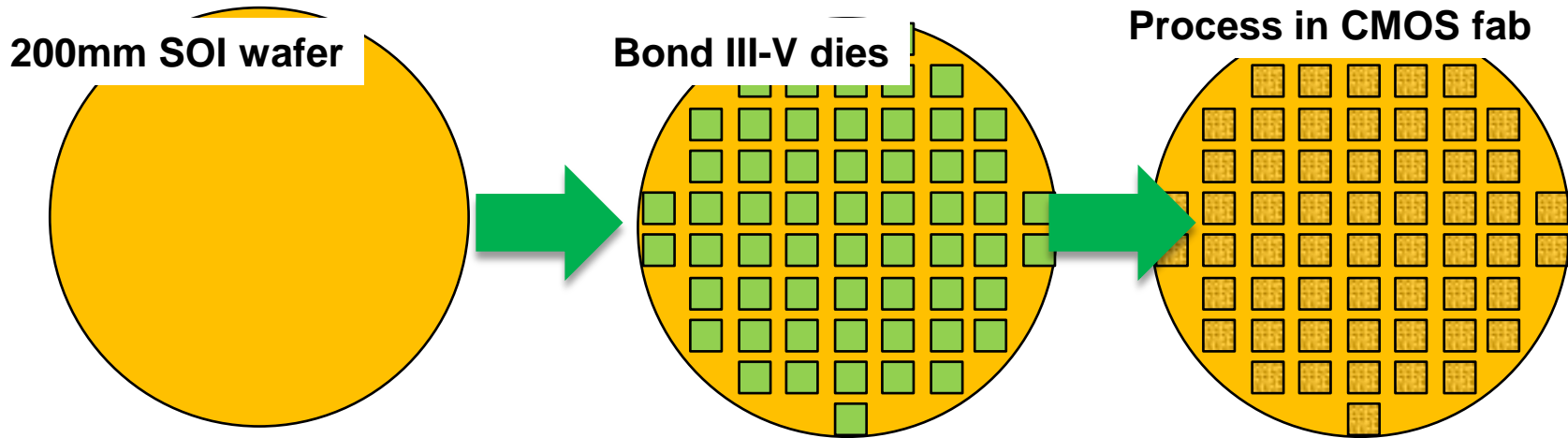

- Need to cover full 200mm wafer (or 300mm ?)
- Need to adapt processes to CMOS fab
 - Gold free contacts
 - III-V etching
 - ...

200mm process development

InP processing in CMOS-fab ? YES !!!

- CEA/LETI demonstrated full laser processing in CMOS pilot line
 - CH_4/H_2 RIE process in 200mm reactor
 - Gold free contacts demonstrated (AlCu/TiN/Ti)

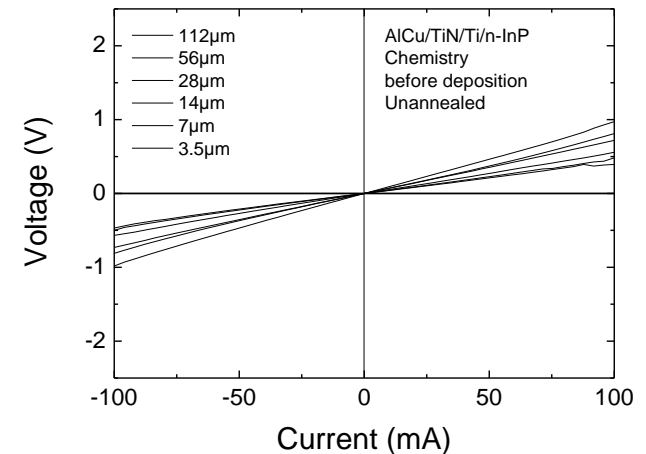
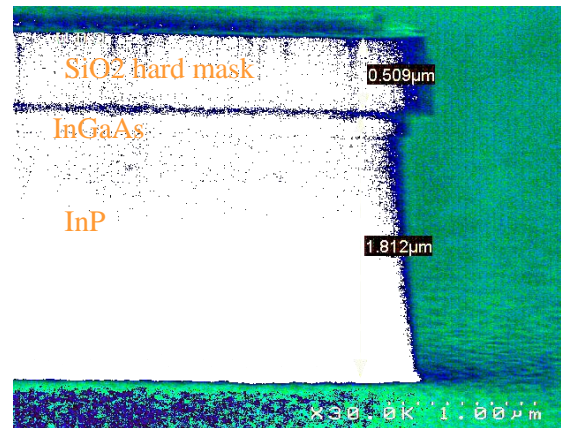
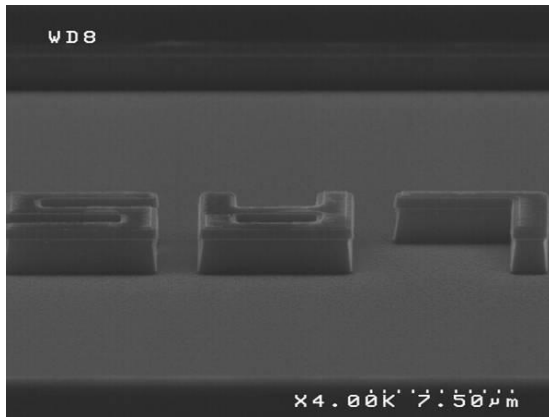

L. Grenouillet e.a., "CMOS compatible contacts and etching for InP-on-silicon active devices", GFP 2009, San Francisco

FP lasers on silicon

- AlGaInAs active layer – $1.3\mu\text{m}$
- individual die processed
 - $\text{CH}_4/\text{H}_2/\text{O}_2$ dry etching
 - metallization + lift off process

1mm-long stripe, pulsed current, 50ns, 1%

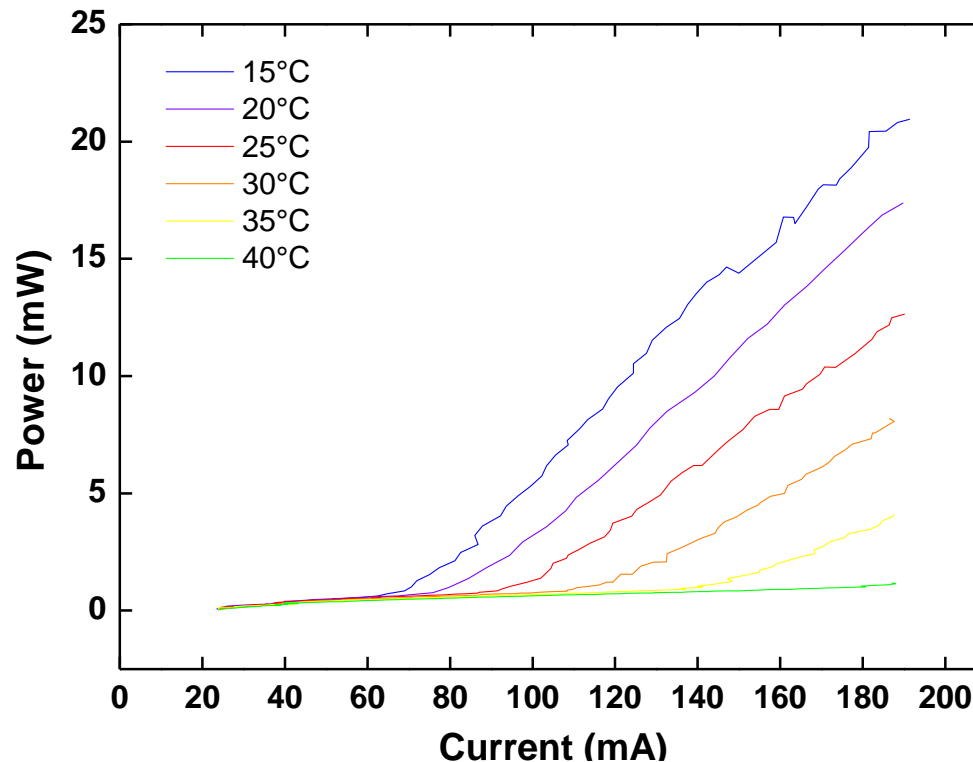

- pulsed operation:

- $L = 1\text{mm}$
- $\lambda = 1.3\mu\text{m}$
- $P > 20\text{ mW}$
- $\text{max } T = 40\text{ C}$

Business model ?

Option I : all CMOS-fab processing

- III-V processing in existing fabs
 - CMOS compatible III-V processing currently not commercially available !
- Considerable loss of silicon real estate
 - Only if silicon is cheap !

Option II : CMOS-fab + III-V fab processing

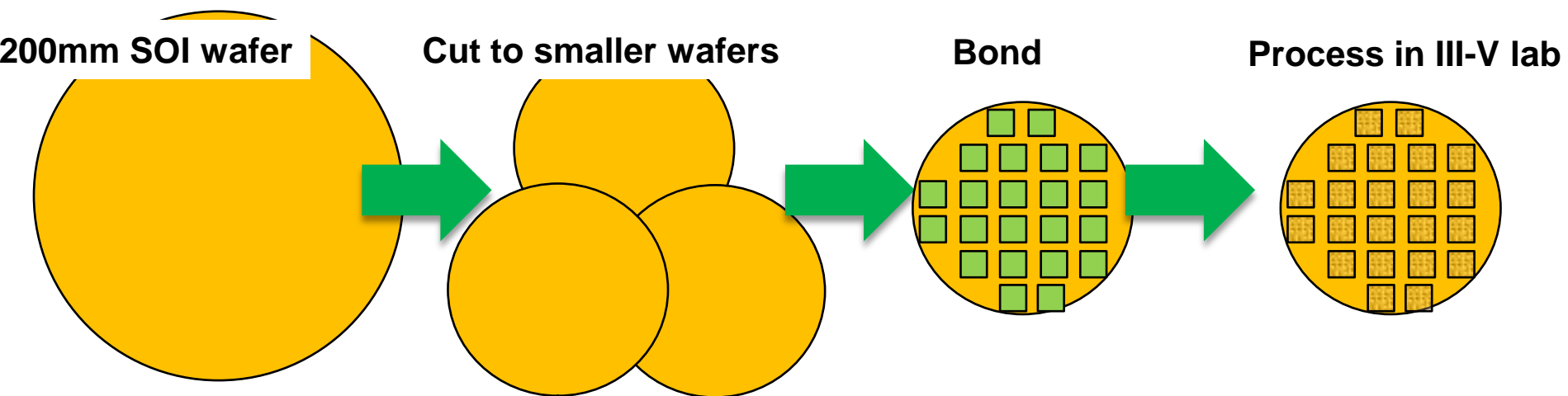

Option II: example

InP HBTs on IBM CMOS (HRL Labs)

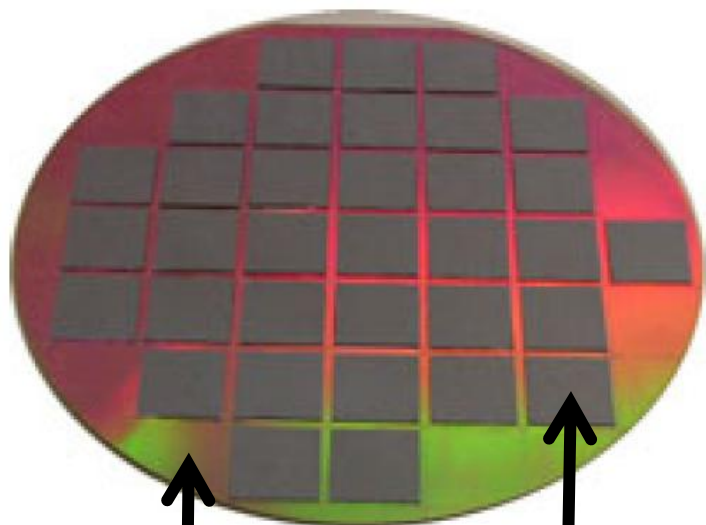

IBM 130nm RF-CMOS
cut to 3 inch wafers

BCB-bonded
unprocessed InP dies

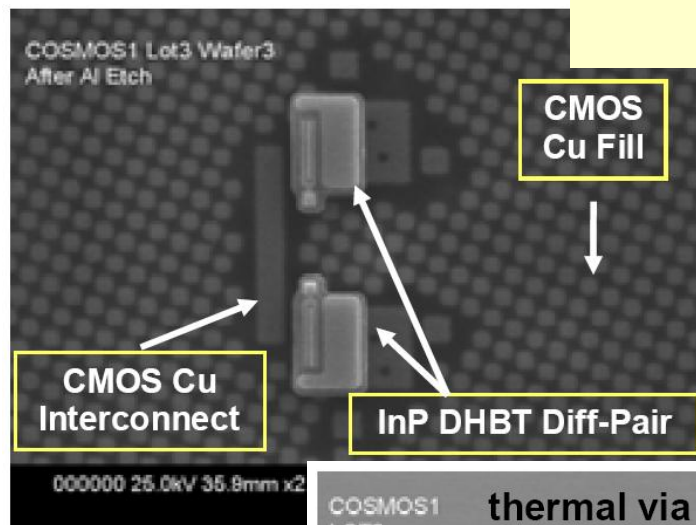

Collective processing
after bonding

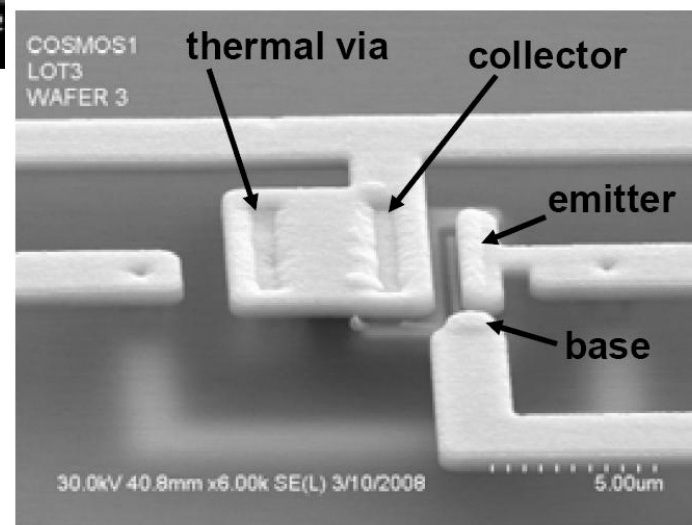

Y. Royter e.a. , "Technology for Dense Heterogeneous Integration of InP HBTs and CMOS," in *CS Mantech*, Tampa, Florida, 2009

Business model

Die bonding ...

OR

Wafer bonding...

- Edge effects may induce bonding effects
- Independent of size silicon wafer (200mm, 300mm ...)
- Total required material may be smaller
- Rapid pick and place process required

- Currently more reliable process
- Largest wafers now available 150mm, 100mm more standard
- Single step process

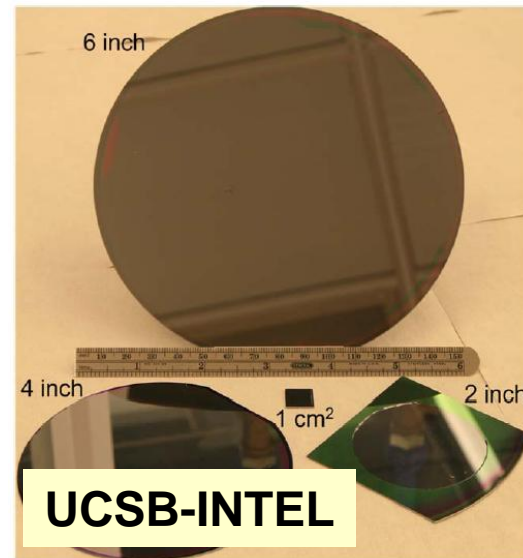
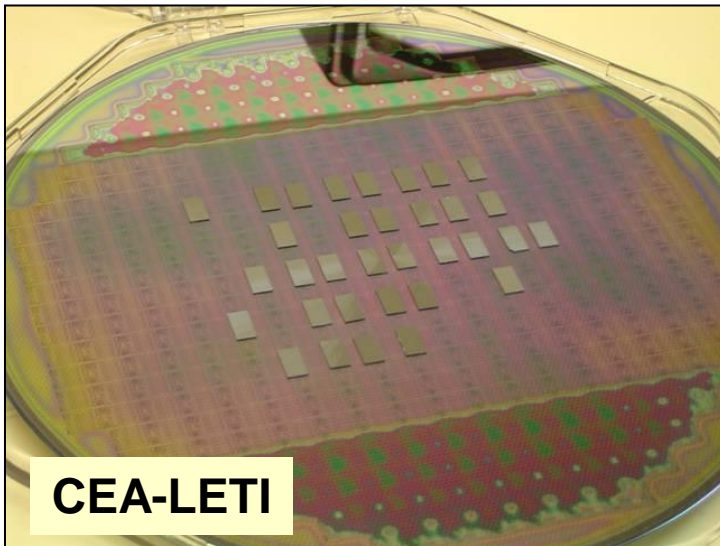

Design options

Light centred in Silicon

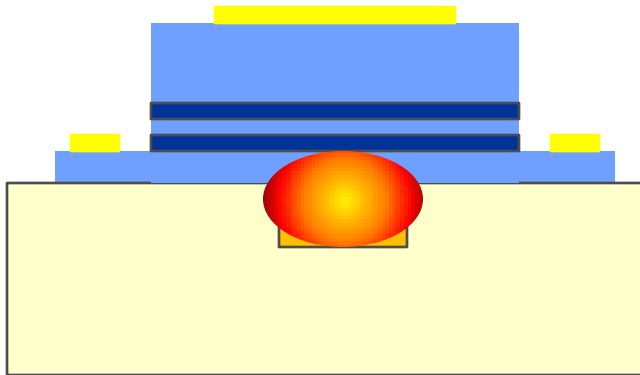

- **High overlap with silicon:**
 - Allows for modal control
 - Easy coupling to waveguide
- **Low overlap with III-V : low gain –high saturation threshold**
- **Not compatible with sub-400nm silicon thickness**

Light centred in III-V

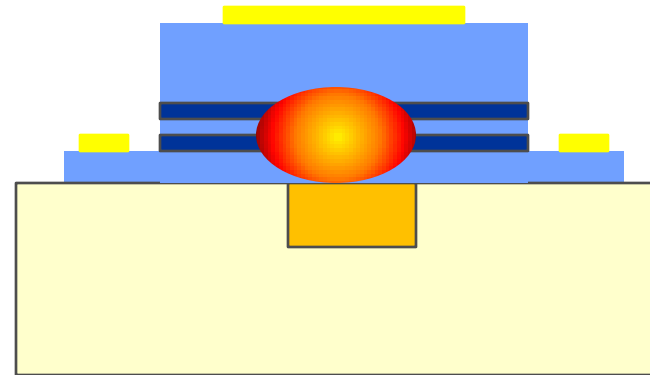

- **High gain**
- **Coupling to silicon may require special structures**

Hybrid evanescent laser

Hybrid evanescent laser (UCSB/INTEL)

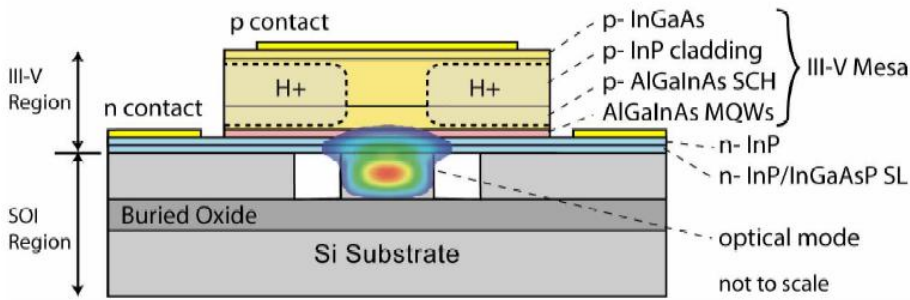

(a)

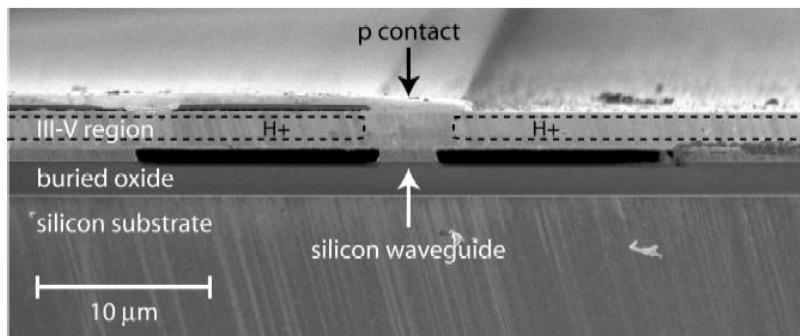

(b)

DFB-laser

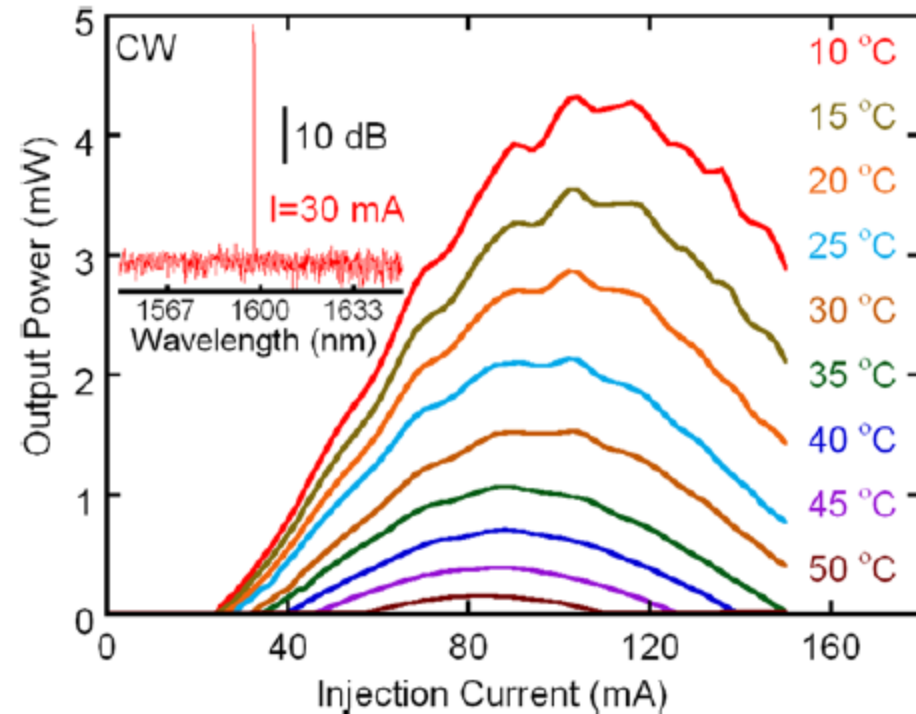

Also:

- DBR-laser, SGDBR-laser, EA-modulator, Detector, Disk laser

Liang, D. et al. Appl Phys a 95, 1045-1057 (2009).

Microdisk laser

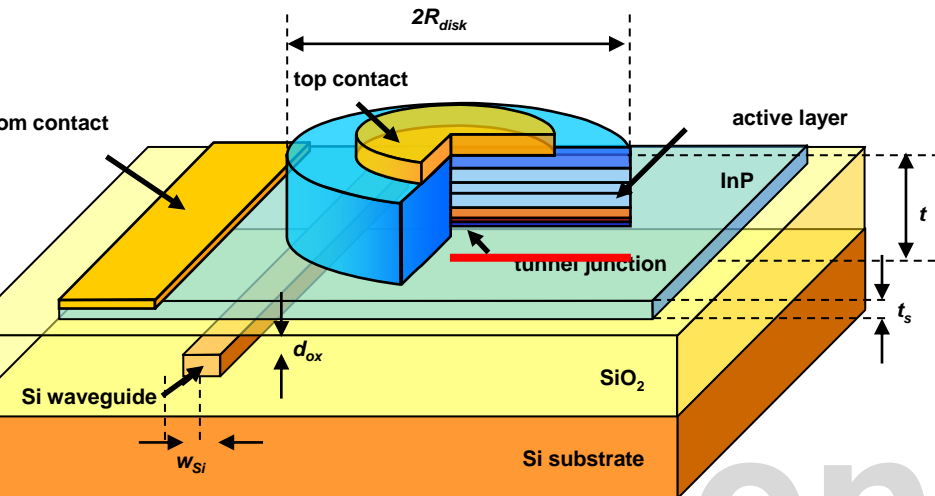

Microdisk laser

- Whispering gallery mode
- Evanescent coupling to silicon
- 150-350 μ A threshold
- 120 μ W output power (CW)

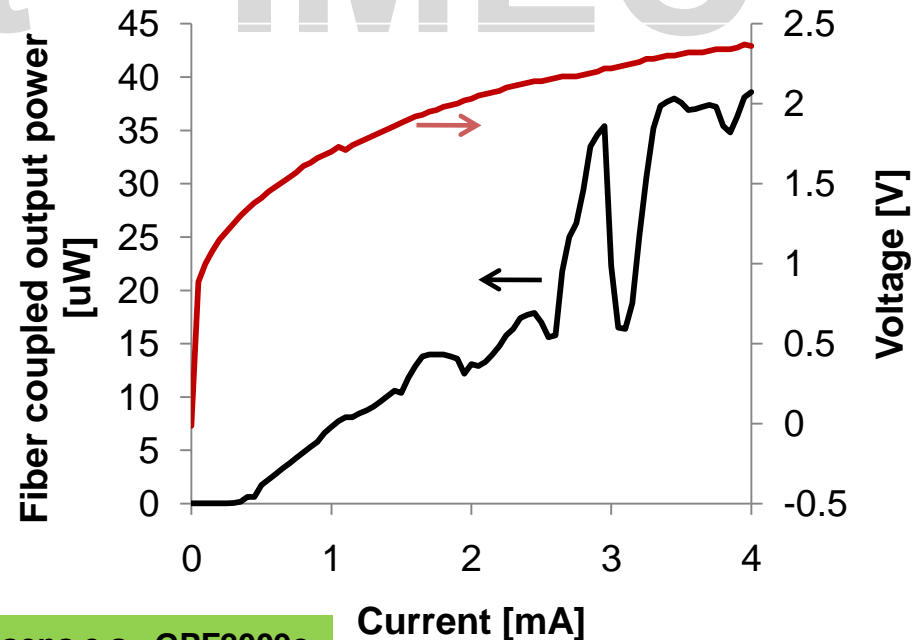
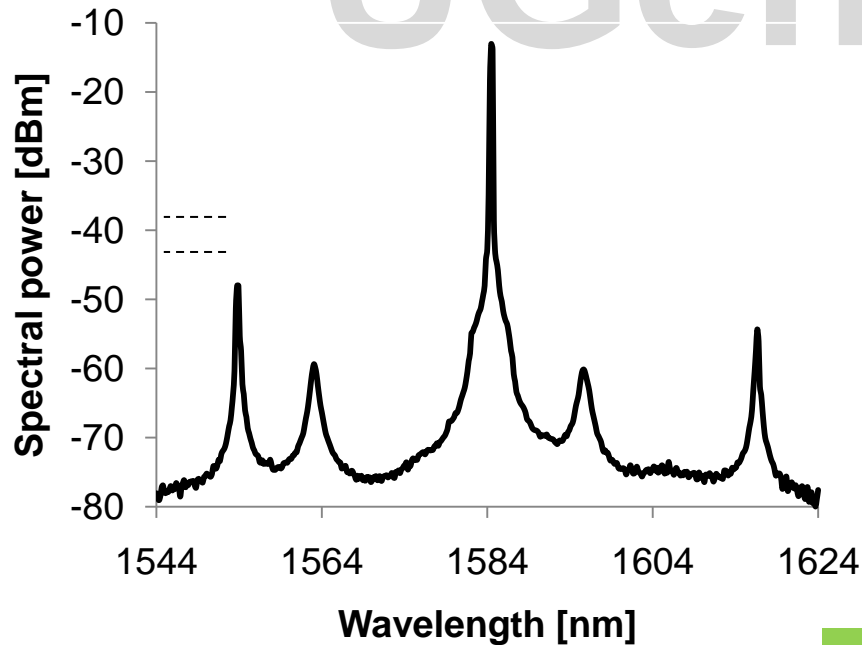

Microdisk device

Very flexible device

- Direct modulation
- Multi-wavelength source

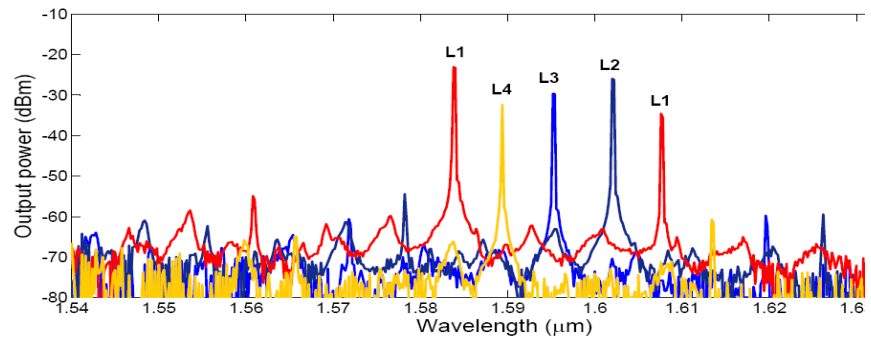
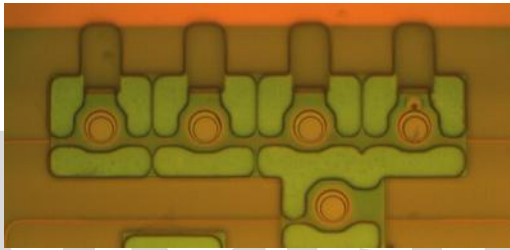

- 20GHz All-optical wavelength conversion Raz e.a. ,OFC2010, paper OMQ5
- 10GHz All-optical gate Kumar e.a. ,OFC2010, paper JWA44
- Electro-optic modulation Liu e.a. , Optics Letters, 33(21), p.2518 (2008)
- All-optical switching
- All-optical flip-flop Liu e.a. , Nat. Phot 2010 + Kumar e.a. , OFC2010, Tuesday

An ultra-small, low-power, all-optical flip-flop memory on a silicon chip

Liu Liu^{1†}, Rajesh Kumar¹, Koen Huybrechts¹, Thijs Spuesens¹, Günther Roelkens¹, Erik-Jan Geluk², Tjibbe de Vries², Philippe Regreny³, Dries Van Thourhout¹, Roel Baets¹ and Geert Morthier^{1*}

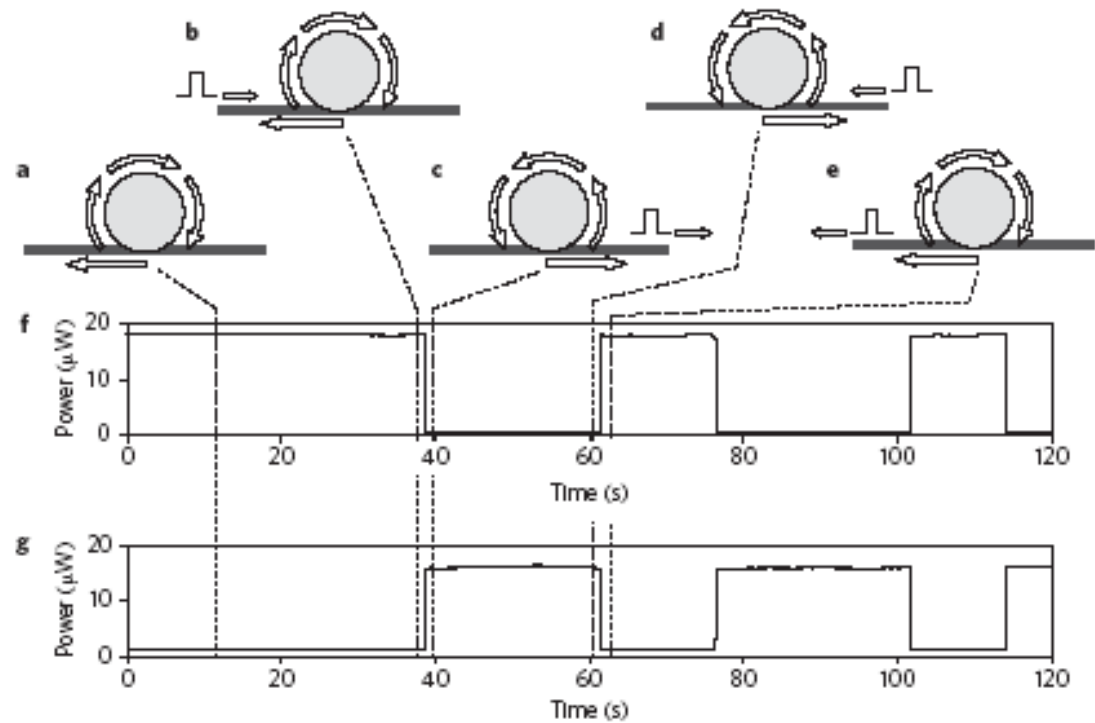
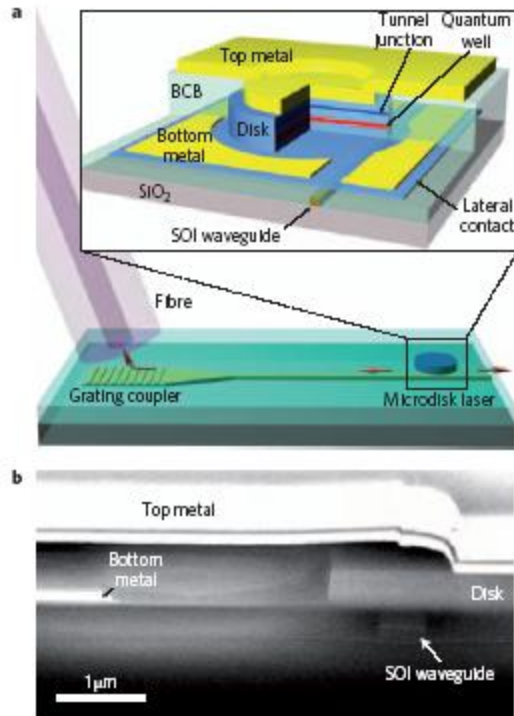

What's next ?

- WDM optical intraconnections on chip with a fully CMOS compatible process
 (EU WADIMOS project <http://wadimos.intec.ugent.be/>)

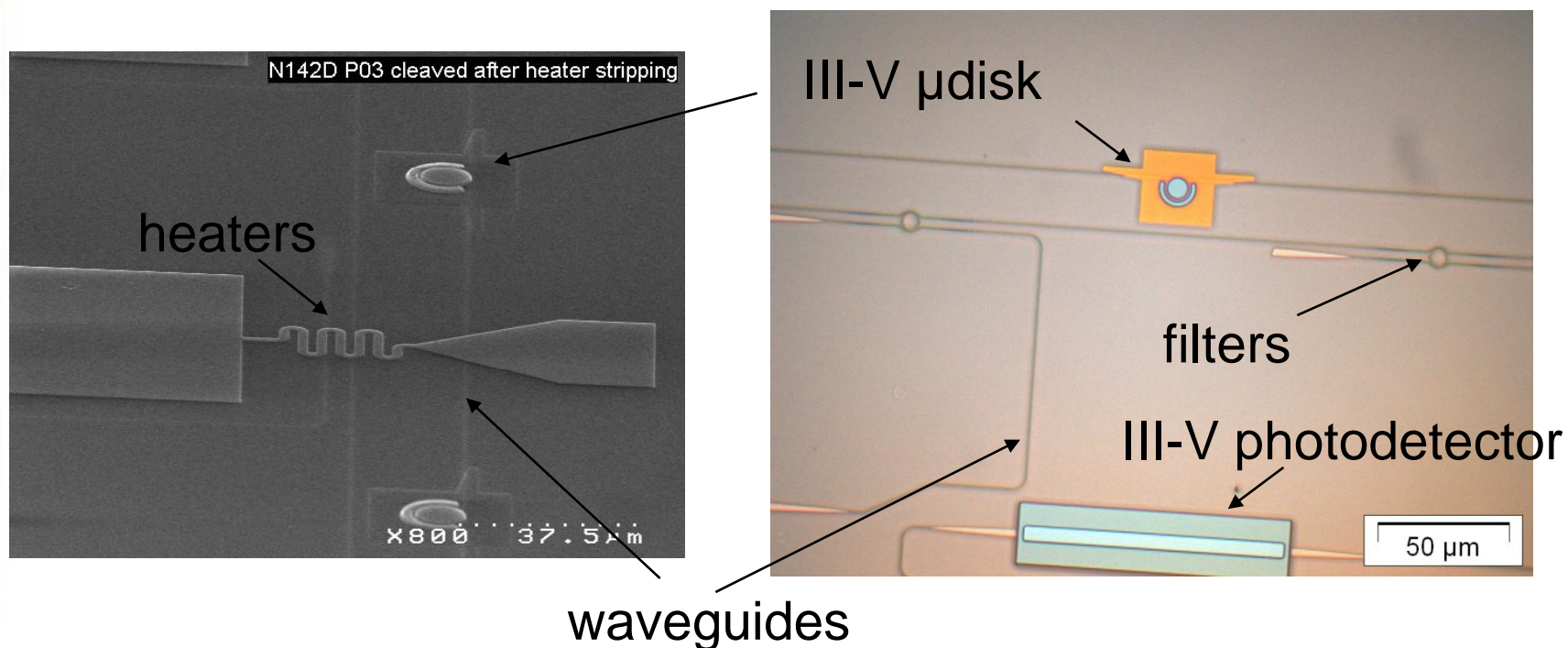

Now lasing !!!!!

© CEA 2009. All rights reserved
 Any reproduction in whole or in part on any medium or use of the information contained herein
 is prohibited without the prior written consent of CEA

Outline

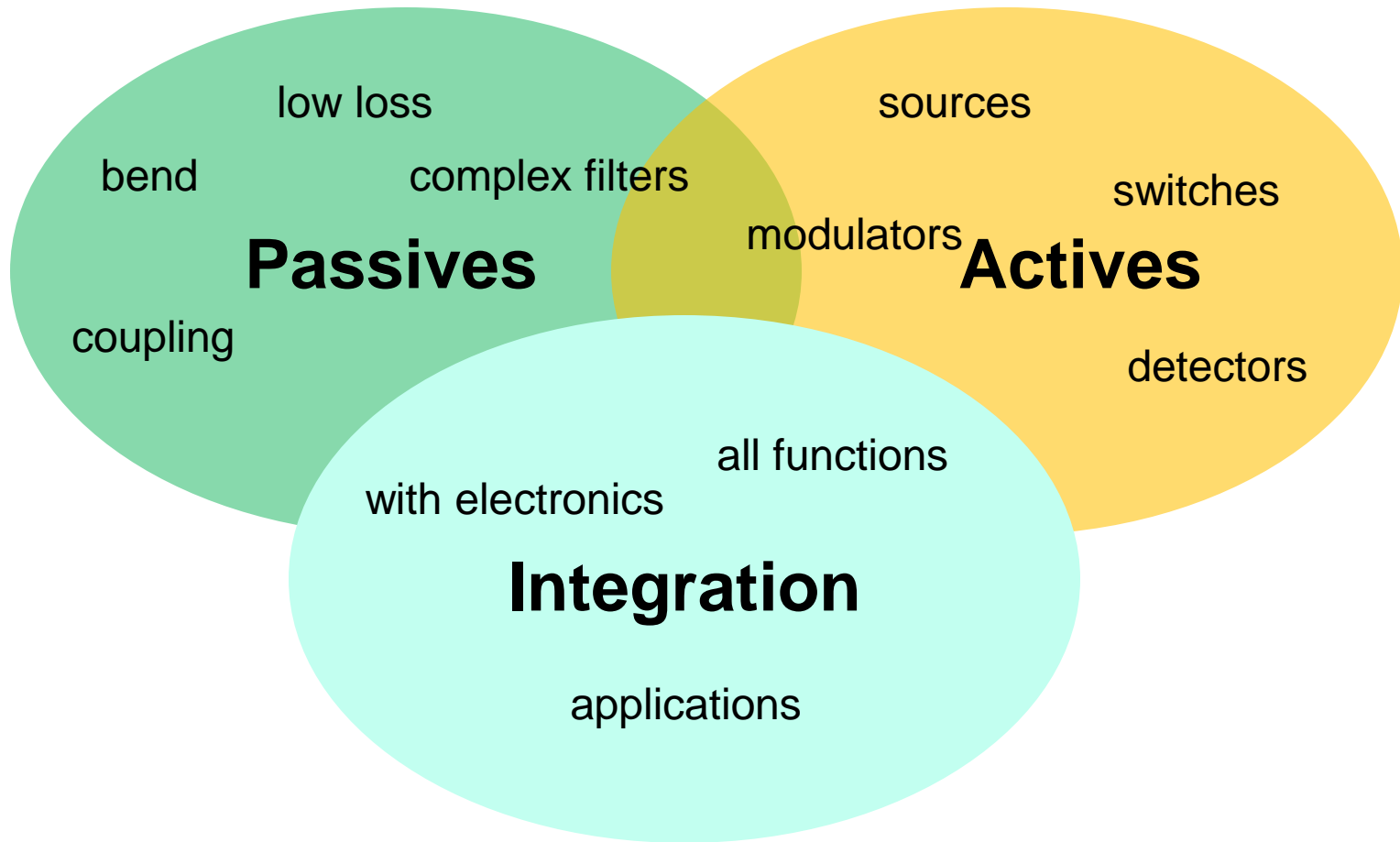

Monolithic vs. 3-D integration

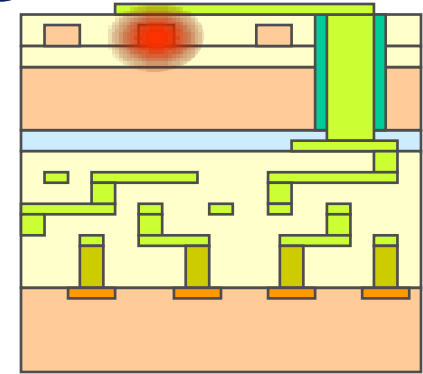
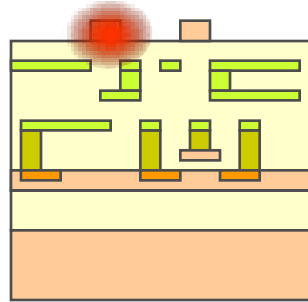
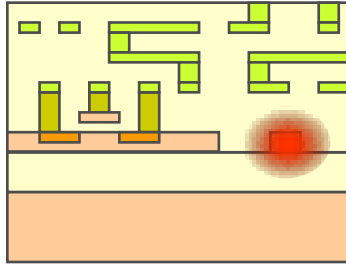

- Front-end: no thermal budget
- Integrated in CMOS flow (on SOI only)
- High process development cost
- Compound yield
- Little flexibility
- Optical layer buried

- Back-end: thermal budget $< 400^{\circ}\text{C}$
- On top of CMOS (or in metal layers)
- Serial process
- Compound yield
- Optical on top is possible

- 3-D: on top of CMOS
- No thermal budget
- Parallel process
- No compound yield problem with die-to-wafer stacking (known good die)
- Flexible choice of electronics and photonics
- Other layers possible: MEMS, antennas
- Optical layer on top is possible

Monolithic vs. 3-D integration

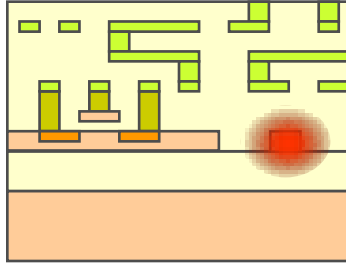

Luxtera

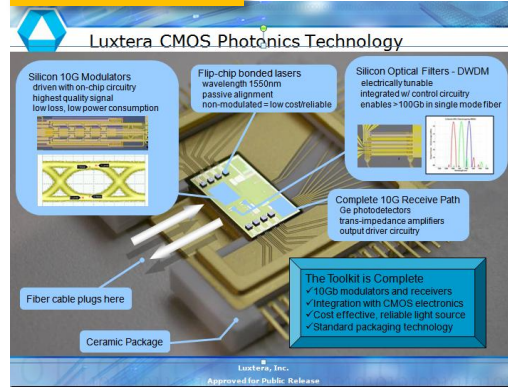

- Front-end: no thermal budget
- Integrated in CMOS flow (on SOI only)
- High process development cost
- Compound yield
- Little flexibility
- Optical layer buried

EPIC project

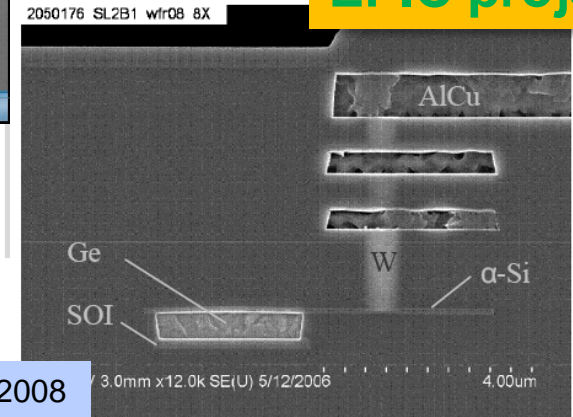

Beals e.a., SPIE Phot West 2008

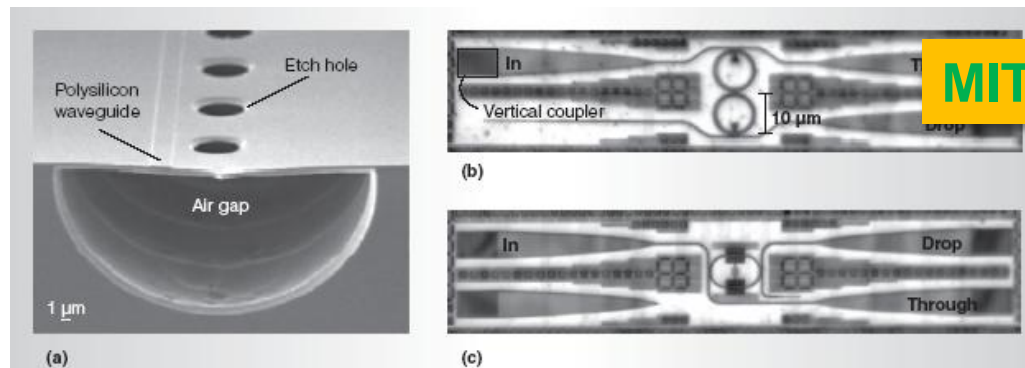

Batten, C. et al. in *IEEE Symp. on HP Interconnects 21-30* Stanford, CA, USA; 2008).

Monolithic vs. 3-D integration

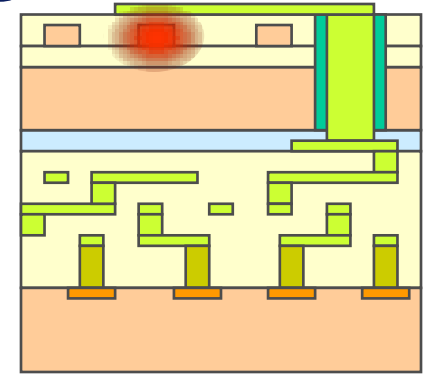
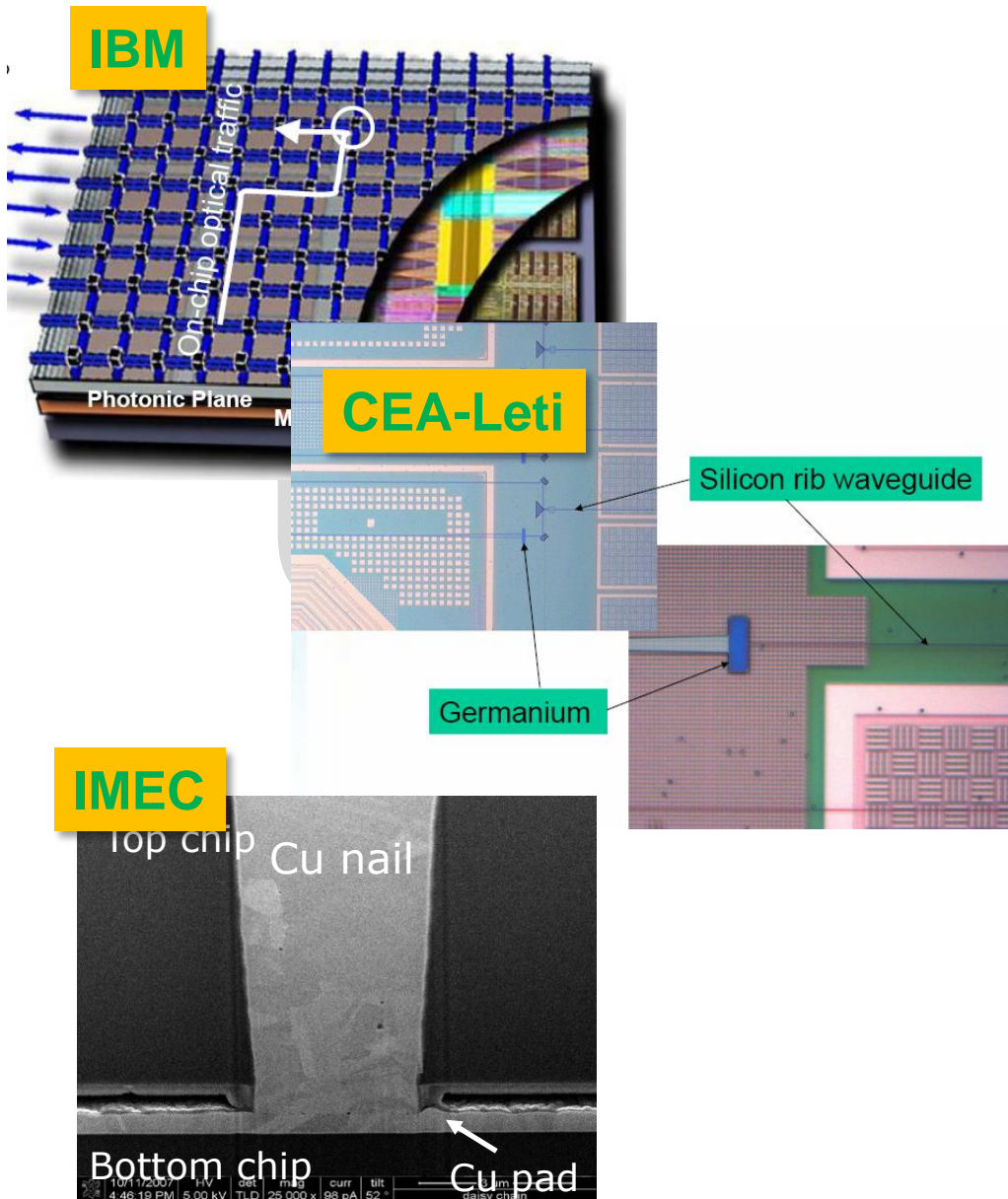

- 3-D: on top of CMOS
- No thermal budget
- Parallel process
- No compound yield problem with die-to-wafer stacking (known good die)
- Flexible choice of electronics and photonics
- Other layers possible: MEMS, antennas
- Optical layer on top is possible



low loss
bend complex filters
sources
switches
integration
applications

Building blocs available !!!

Time to integrate and find the right application

Acknowledgements

Thanks to

- Ghent University/IMEC Photonics Research Group
 - (in particular Wim Bogaerts who provided a lot of the slides)



UGent

- ePIXfab project for silicon fabrication
 - See www.epixfab.eu : also for YOU!!!
- Funding through national and EU research projects



PhotonFAB

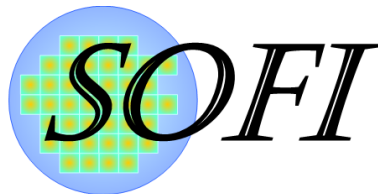

Silicon Photonics Forum

Building the food chain from research to the market

Friday 30 April 2010

**imec auditorium, Leuven, Belgium
10h30 – 17h**



Design

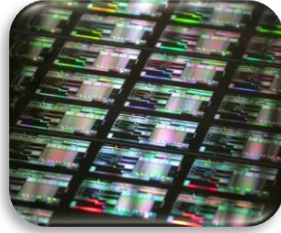

Prototyping

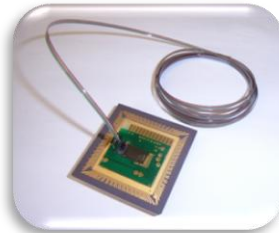

Packaging



Manufacturing



Training

- Learn about the fabless supply chain
- Discuss the future of fabless silicon photonics
- Silicon photonics tutorial 8h30-10h

Keynote: Cary Gunn, experiences from Genalyte and Luxtera

Speakers include PhoeniX, AMO, OptoCAP, DAS photonics, KTH, XiO, TU Berlin, NTU Athens, PoliMi, imec, ...

Registration & venue: www.epixfab.eu