

COLLOIDAL QUANTUM DOTS AS ACTIVE MATERIALS FOR SIN PHOTONICS

Candidate: Yunpeng Zhu^{1,3}

Promotor: Prof. Dries Van Thourhout^{1,3}, Prof. Zeger Hens^{2,3}

¹Photonics Research Group, INTEC Department, Ghent University-IMEC, Ghent B-9000, Belgium

²Physics and Chemistry of Nanostructures, Ghent University, Krijgslaan 281-S3, 9000 Ghent, Belgium

³Center of Nano and Biophotonics (NB Photonics), Ghent University, Ghent B-9000, Belgium

OUTLINE

- Motivation
- Colloidal quantum dots as light emitting material
- SiN waveguide platform optimization
- Colloidal quantum dots as gain material
- Colloidal quantum dots as single photon emitter
- Conclusion

MOTIVATION

- Silicon nitride photonics
 - Low loss compared with silicon photonics : 0.001 dB/cm to 0.5 dB/cm
 - Large optical transparent window: 0.4 μm to 4 μm
 - Relatively high index contrast: ~ 2
 - Layer stack flexibility: Multi layer is doable with multi deposition
 - ☹ Not a good material for light generation

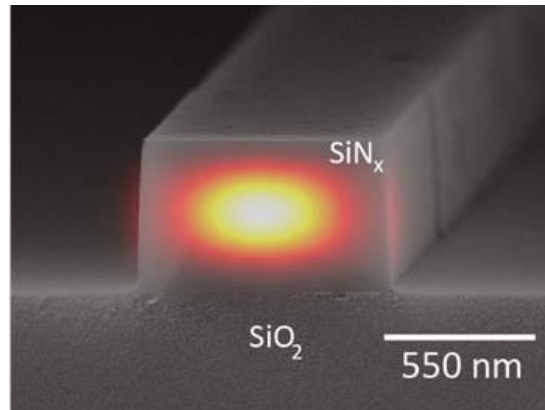

MOTIVATION

- Colloidal quantum dots

- High quantum yield:
- Tunability of the emission:
- Low cost:
- Optical gain & single photon emission

up to 80-90%

0.4 μm to $\sim 1.6 \mu\text{m}$

chemical synthesis without vacuum chamber

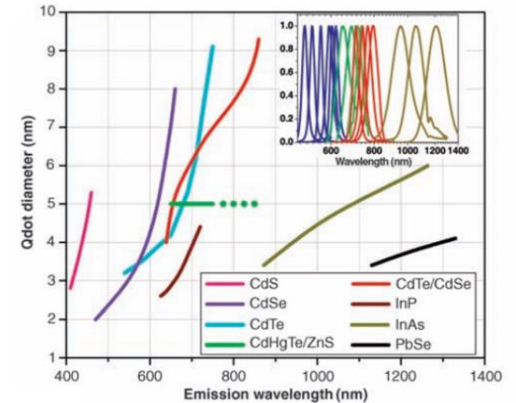
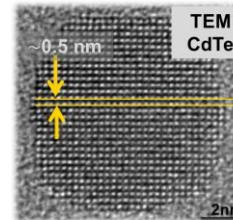
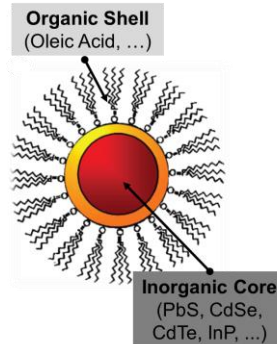

MOTIVATION

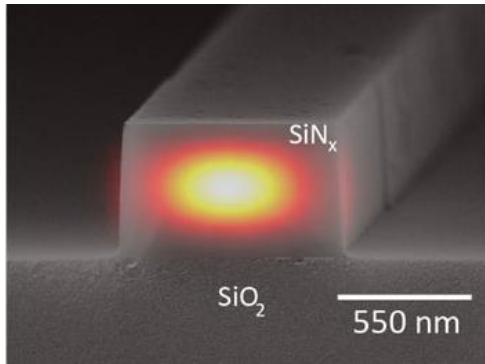

- Low loss
- Large optical transparent window
- Relatively high index contrast
- Layer stack flexibility
- ☹️ Not a good material for light generation

+

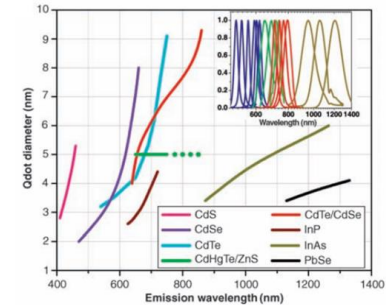

- Low cost
- Tunability of emission
- High quantum yield
- Optical gain
- Single photon emission

OUTLINE

- Motivation
- Colloidal quantum dots as light emitting material
- SiN waveguide platform optimization
- Colloidal quantum dots as gain material
- Colloidal quantum dots as single photon emitter
- Conclusion

COLLOIDAL QUANTUM DOTS AS LIGHT EMITTING MATERIAL

- Quantum dots as gain material
 - Potential high gain coefficient
 - Potential low lasing threshold
 - Potential thermal insensitive optical gain
 - Quantum confinement providing wide range of gain spectrum tunability
- Colloidal quantum dots
 - Low cost
 - Flexibility with the substrate

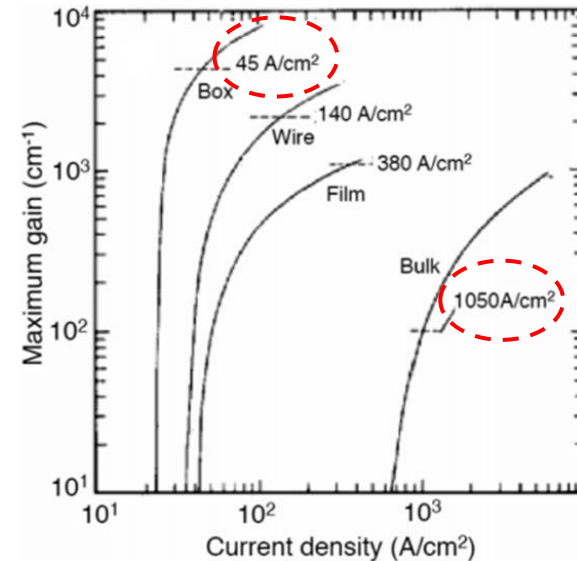

Asada, Mashiro *et al.* *IEEE Journal of quantum electronics* 22, no. 9 (1986): 1915-1921.

COLLOIDAL QUANTUM DOTS AS LIGHT EMITTING MATERIAL

- Biexciton gain

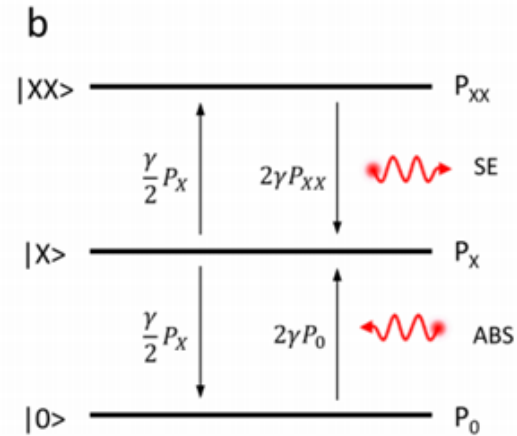
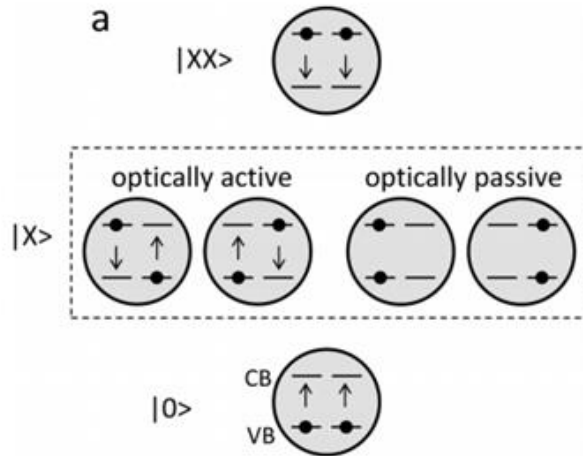

Y. Park, *et al. Nano letters* 15, no. 11 (2015): 7319-7328.

COLLOIDAL QUANTUM DOTS AS LIGHT EMITTING MATERIAL

- Auger recombination
 - The enhanced Auger recombination in colloidal QDs deactivate the optical gain
 - Can be beneficial for the single photon emission

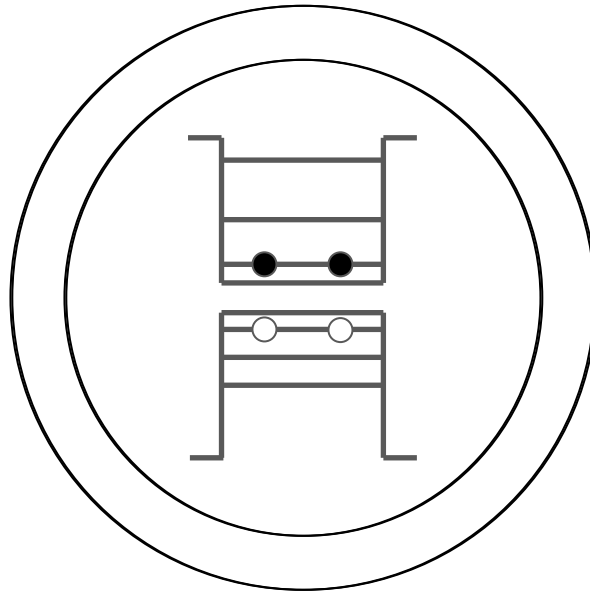

COLLOIDAL QUANTUM DOTS AS LIGHT EMITTING MATERIAL

- Colloidal QDs as single photon emitter
 - Fast Auger process leads to the quenching of multi-excitons
 - Single photon emission properties can be achieved with colloidal QDs

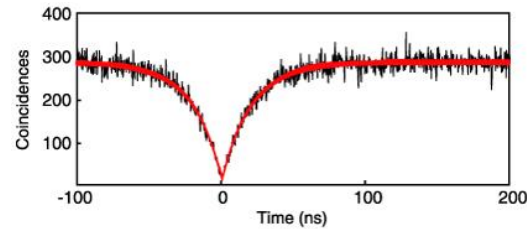

CW excitation

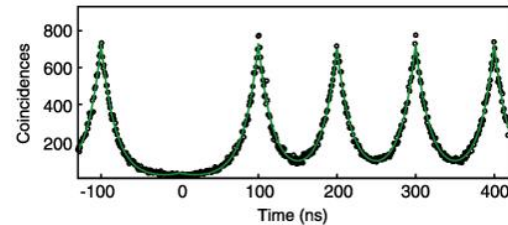

Pulsed excitation

Brokmann, X. *et al.* *New Journal of Physics* 6, no. 1 (2004): 99

OUTLINE

- Motivation
- Colloidal quantum dots as light emitting material
- **SiN waveguide platform optimization**
- Colloidal quantum dots as gain material
- Colloidal quantum dots as single photon emitter
- Conclusion

SiN WAVEGUIDE PLATFORM OPTIMIZATION

- The goal of the waveguide platform optimization
 - Low loss SiN waveguide
 - Low loss SiN waveguide with embedded colloidal QDs
 - The embedded colloidal QDs still maintain their emission properties

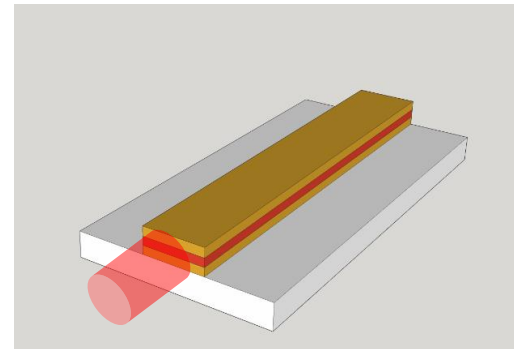
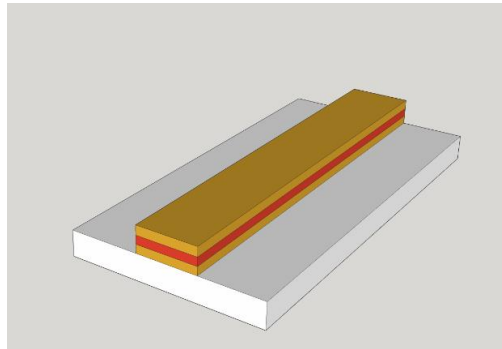
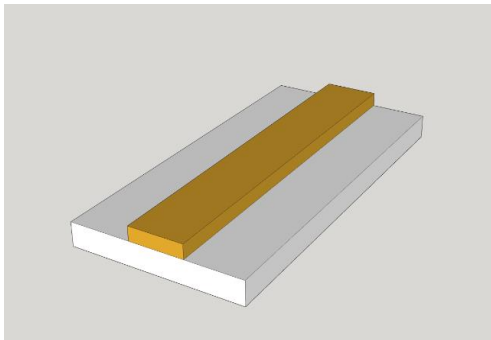

SiN WAVEGUIDE PLATFORM OPTIMIZATION

- SiN deposition

	Frequency	Bias Power	Pressure (mT)	N ₂ (sccm)	NH ₃ (sccm)	SiH ₄ (sccm)
H-F	13.56 MHz	30 W	650	1960	40	40
L-F	100 kHz	50 W	650	1960	35	40
M-F	6:1.5(H:L)	30W/50W	650			

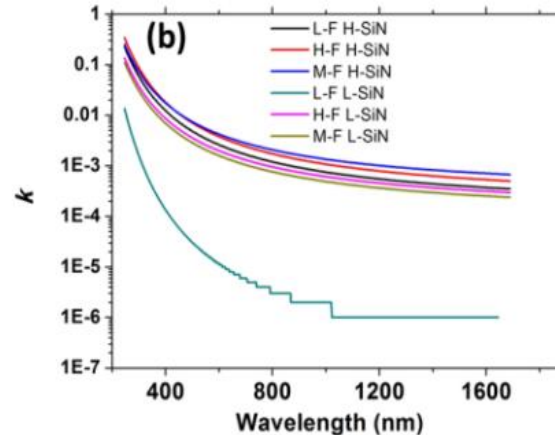
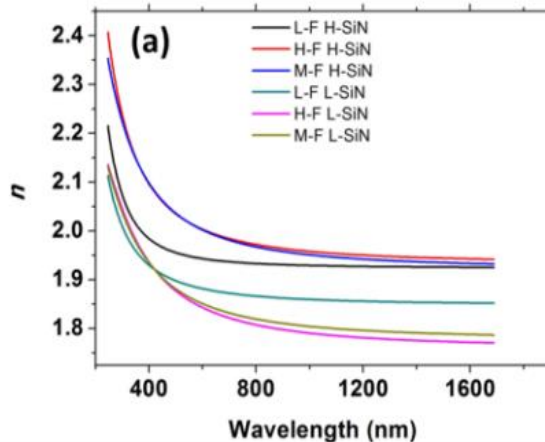

SiN WAVEGUIDE PLATFORM OPTIMIZATION

Pure SiN waveguide:
200 nm thick with different width @ 900 nm

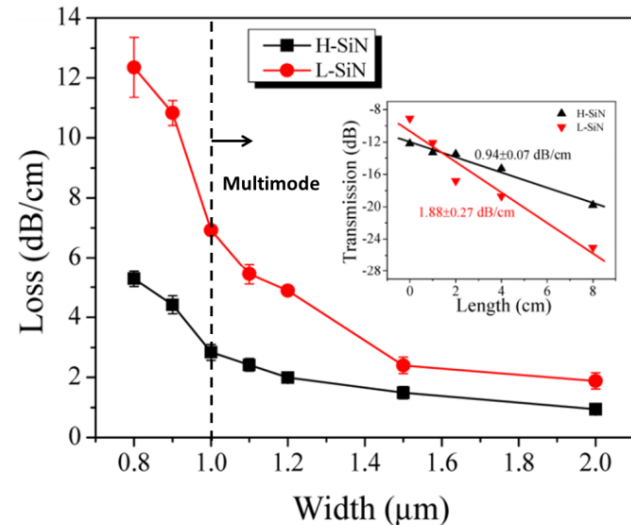
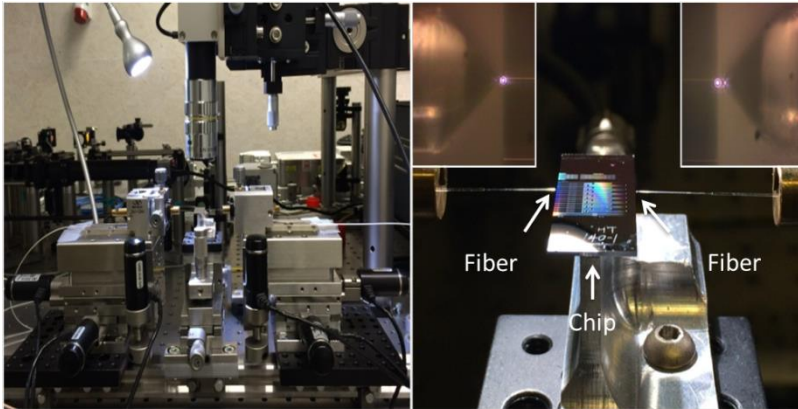
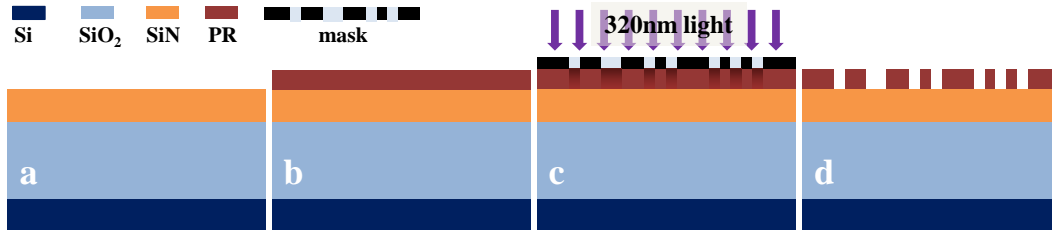

SiN WAVEGUIDE PLATFORM OPTIMIZATION

SiN waveguide with CQDs embedded:
100 nm H-SiN + monolayer CQDs+ 100 nm L-SiN @ 900 nm

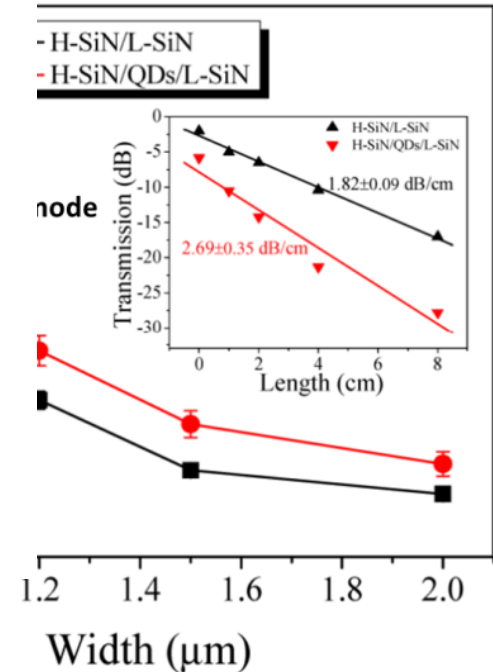
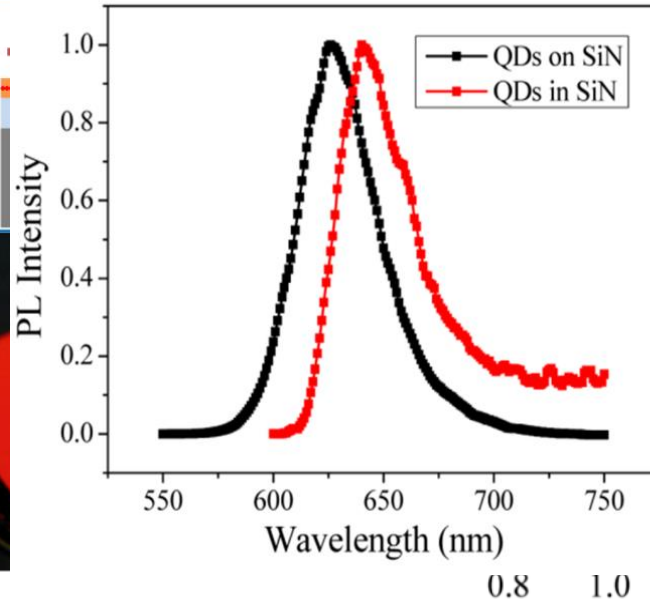
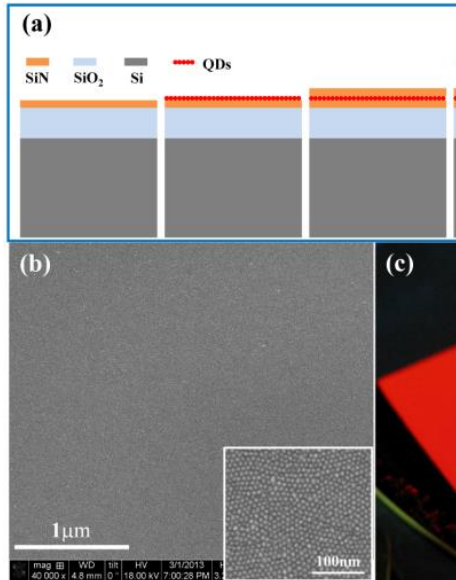

SiN WAVEGUIDE PLATFORM OPTIMIZATION

- SiN layer stress characterization

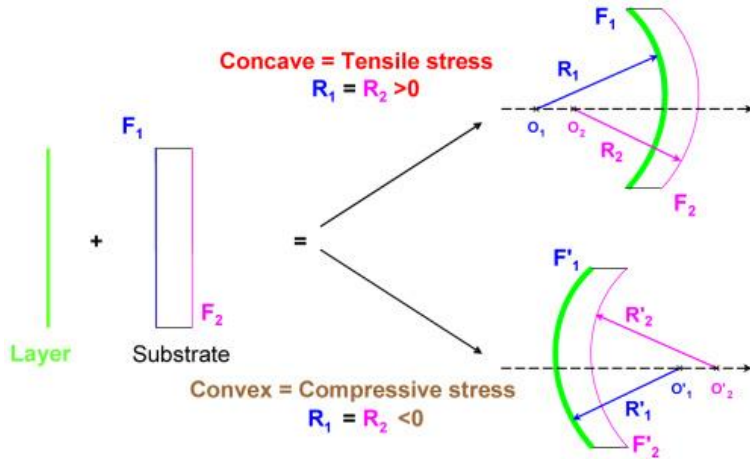

$$\sigma_{total} = \frac{E_s d_s^2}{6(1 - \nu_s)} \frac{1}{\sum_{i=1}^n d_i} \left(\frac{1}{R_{total}} - \frac{1}{R_{substrate}} \right)$$

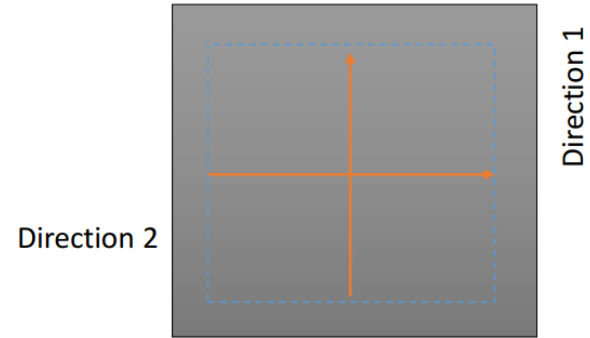

Scheme of the profiler scanning trace

SiN Type	Stress Type	Average Stress (MPa)
H-F SiN	Tensile	774
M-F SiN	Tensile	400
L-F SiN	Compressive	1046

SiN WAVEGUIDE PLATFORM OPTIMIZATION

- SiN fluorescence measurement

$$\text{Counts per nm} = \frac{\text{Total Counts} - \text{Background Counts}}{\text{thickness of SiN}}$$

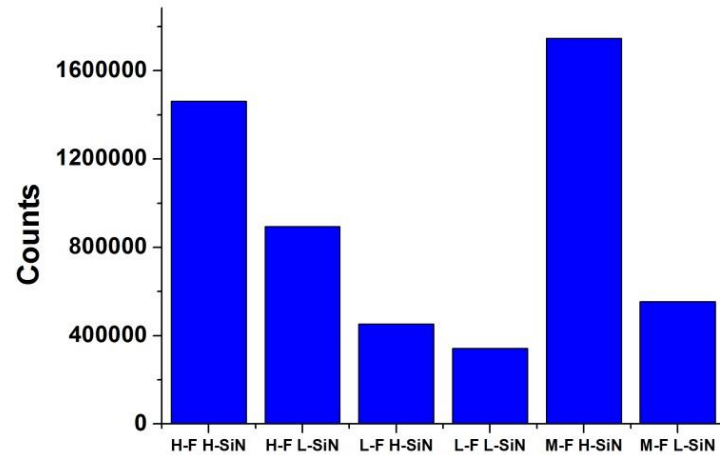
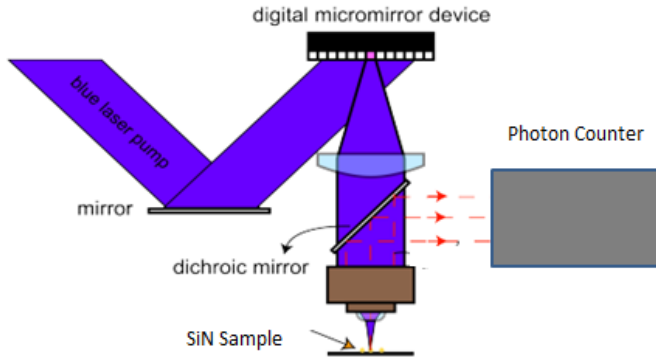

OUTLINE

- Motivation
- Colloidal quantum dots as light emitting material
- SiN waveguide platform optimization
- **Colloidal quantum dots as gain material**
- Colloidal quantum dots as single photon emitter
- Conclusion

COLLOIDAL QUANTUM DOTS AS GAIN MATERIAL

- Colloidal QDs photoluminescence characterization

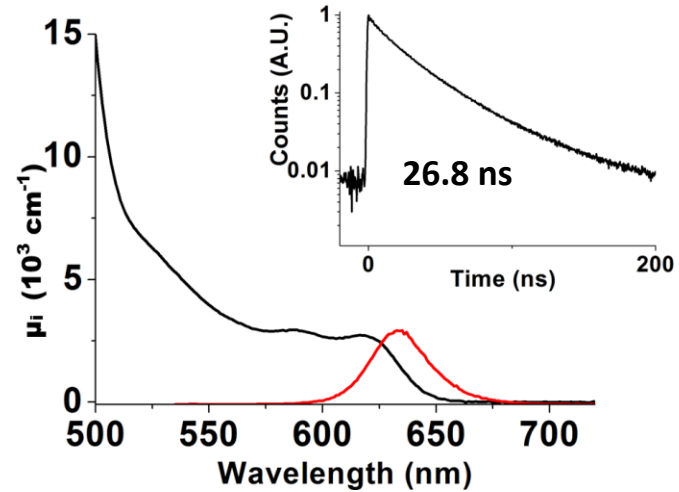
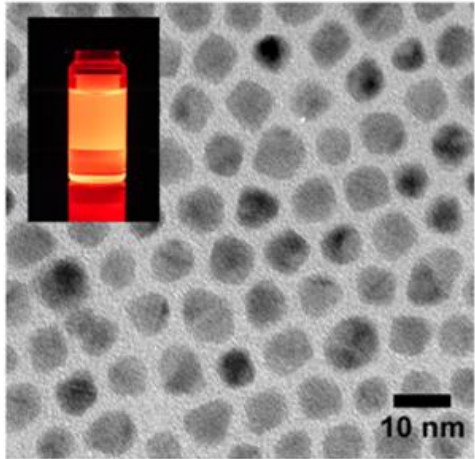

Absorption coefficient and emission spectrum. Inset: decay time

COLLOIDAL QUANTUM DOTS AS GAIN MATERIAL

- Transient absorption spectroscopy

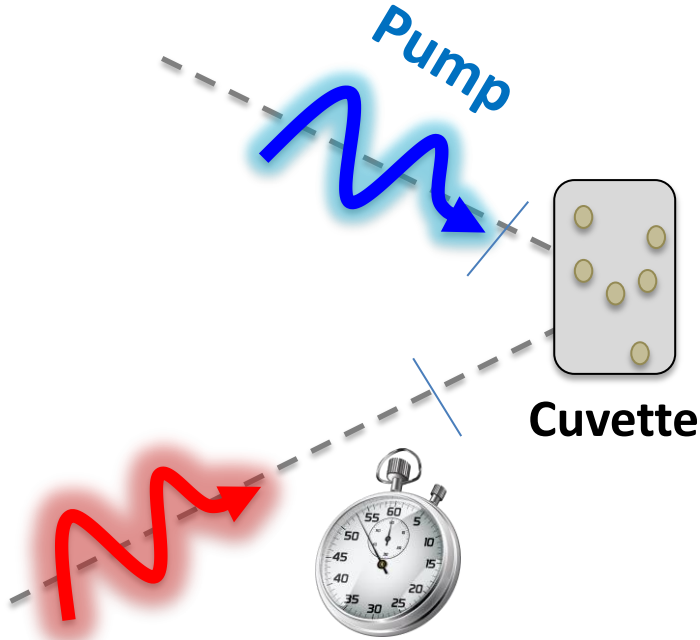

Time Delay

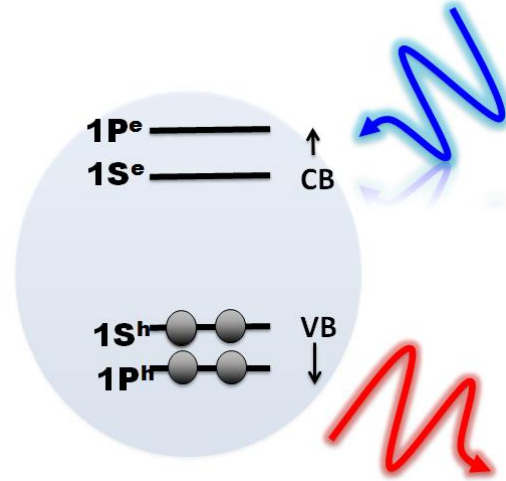

$$\Delta A = A - A_0$$

Transparency: $\Delta A = A_0$, or eq. : $A = 0$

Net optical gain: $A < 0$, or eq. : $G (= -A) > 0$

Get exciton lifetime and gain spectrum information

COLLOIDAL QUANTUM DOTS AS GAIN MATERIAL

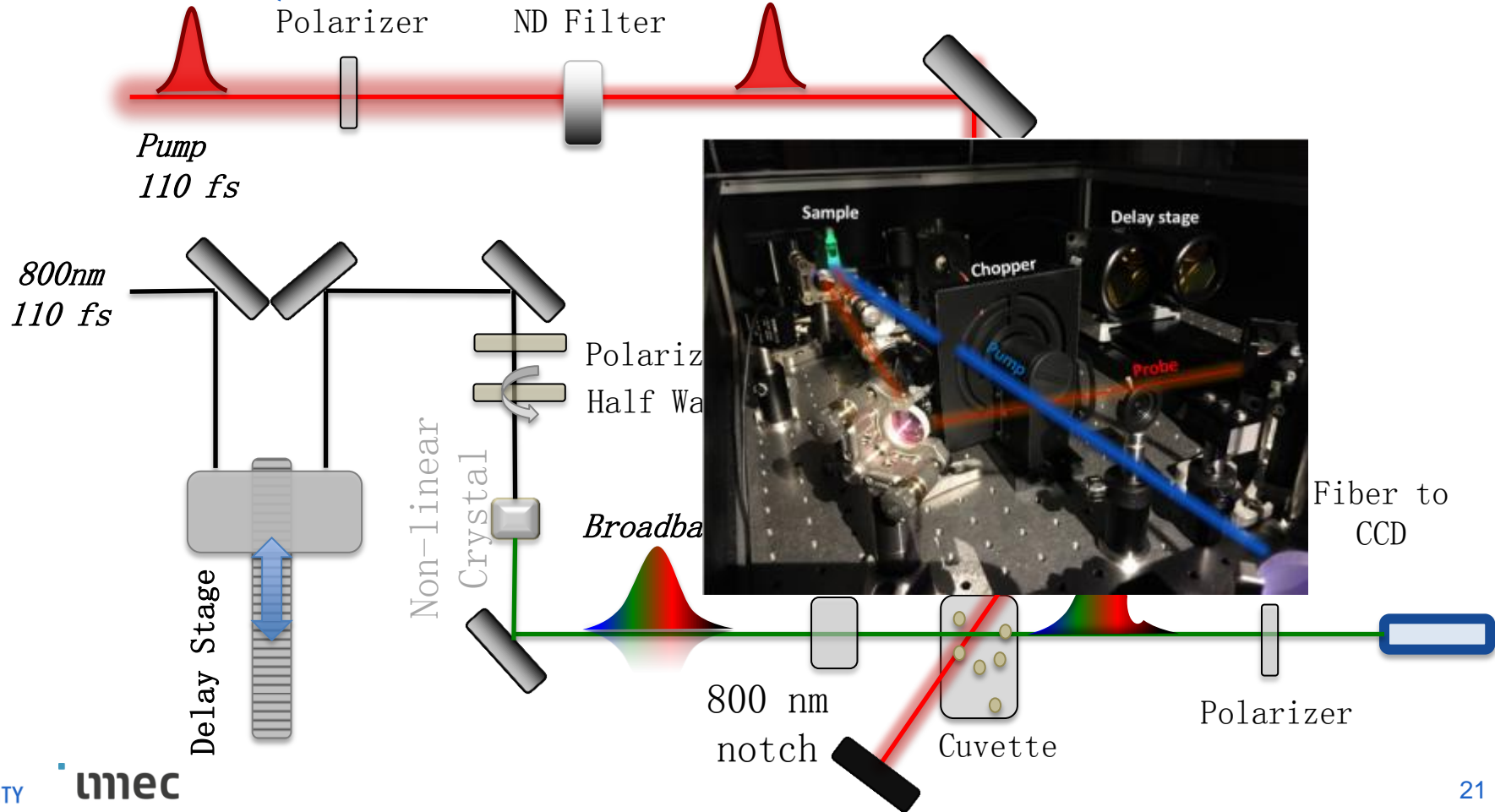

COLLOIDAL QUANTUM DOTS AS GAIN MATERIAL

- TAS measurement results

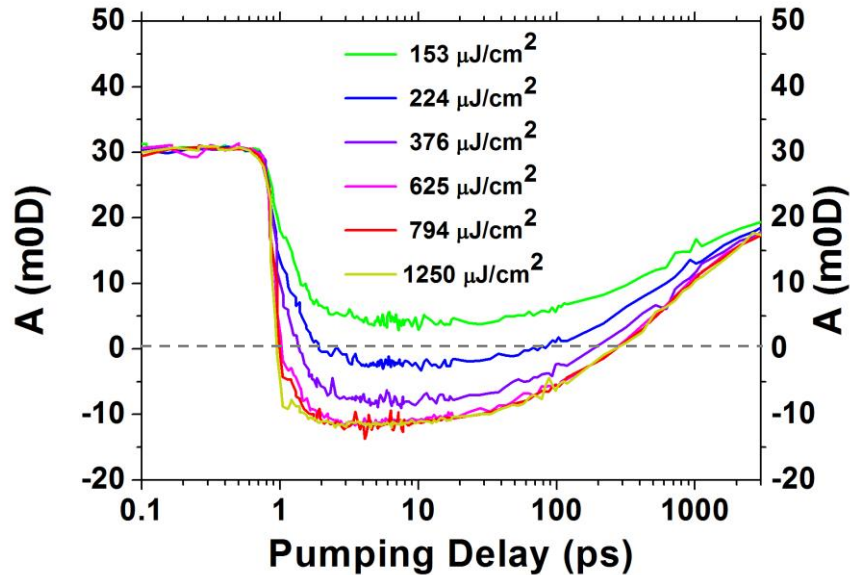

The time dependent dynamics of A at a fixed probe wavelength of 630 nm after 520 nm excitation. The lowest fluences used has a rate constant of $\sim 2 \text{ ns}^{-1}$ (500 ps bi-exciton lifetime)

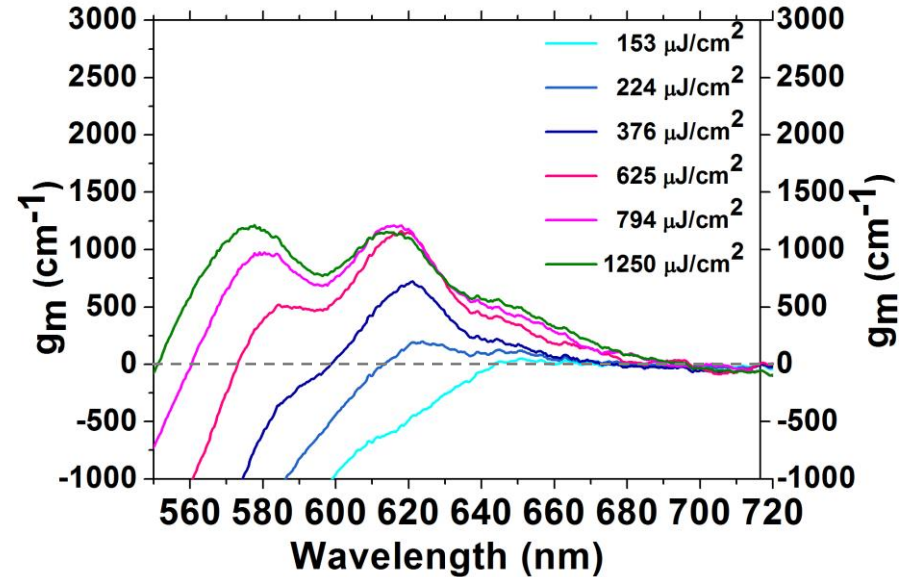

$$g_m(\lambda, t) = -A(\lambda, t) \frac{\mu_{i,0}(\lambda_{ref})}{A_0(\lambda_{ref})}$$

Material gain at 2.5 ps for pumping at 520 nm

COLLOIDAL QUANTUM DOTS AS GAIN MATERIAL

- Compact layer gain coefficient measurement

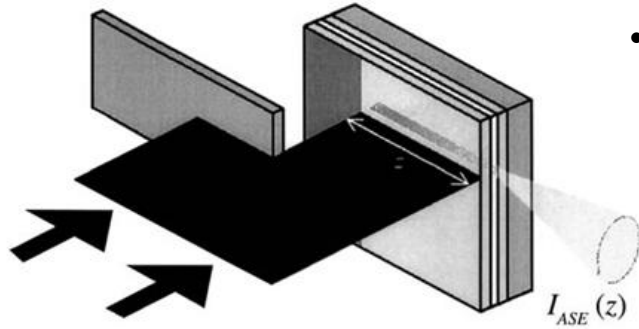

- **Variable stripe length (VSL) for gain coefficient measurement**

Pros

- No special sample preparation is needed

Cons

- Diffraction of the pumping beam can lead to artificial gain values
- Z-dependence of $\Omega(z)$ strongly affects the collection efficiency of the ASE signals

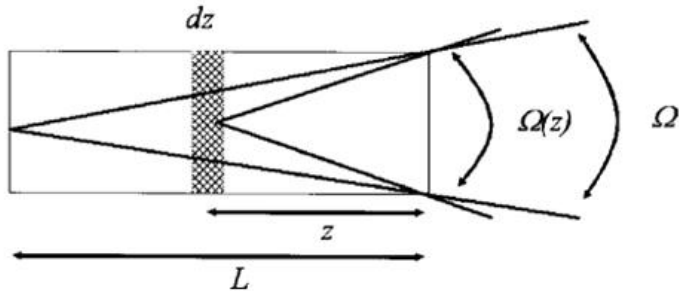

Waveguide based variable stripe length method

COLLOIDAL QUANTUM DOTS AS GAIN MATERIAL

- Compact layer gain coefficient measurement

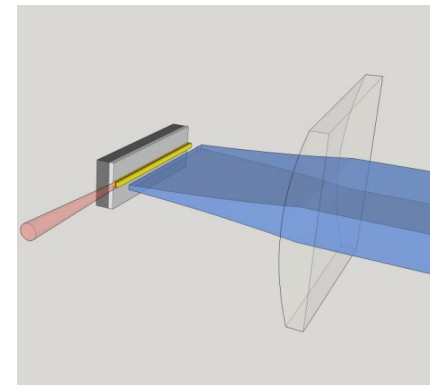
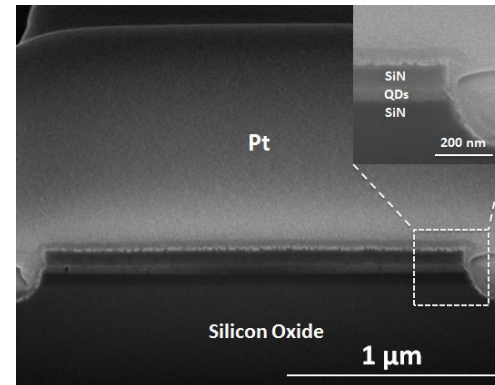
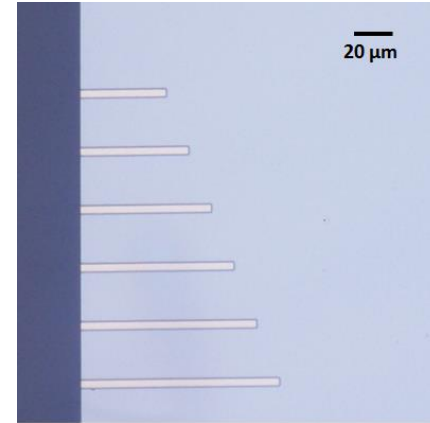
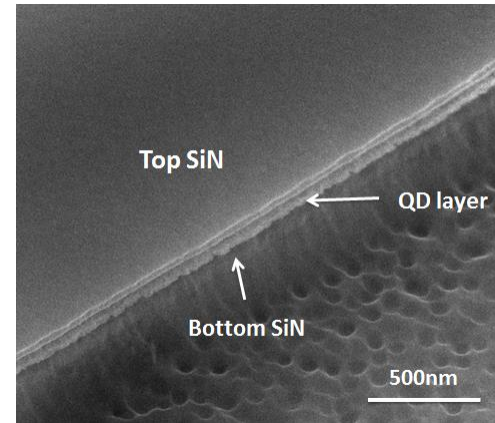
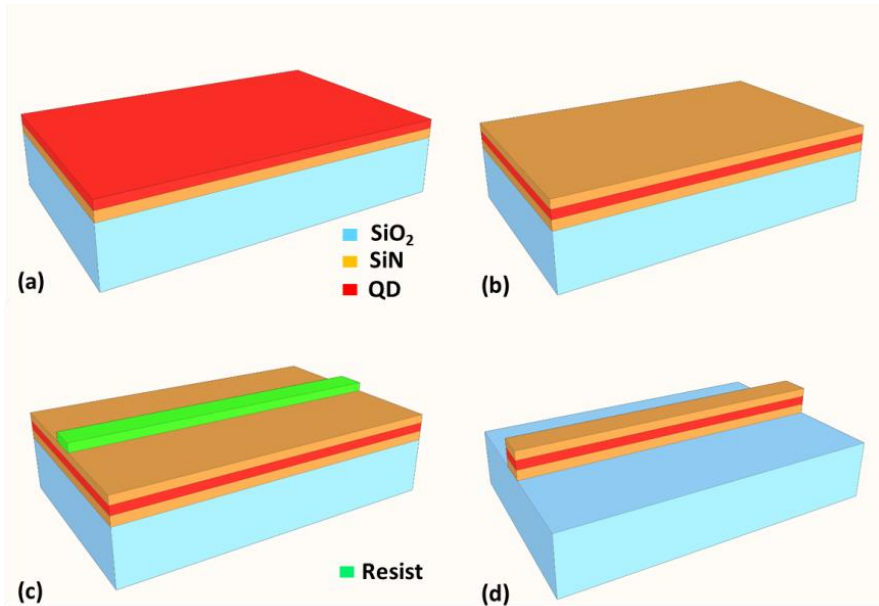

COLLOIDAL QUANTUM DOTS AS GAIN MATERIAL

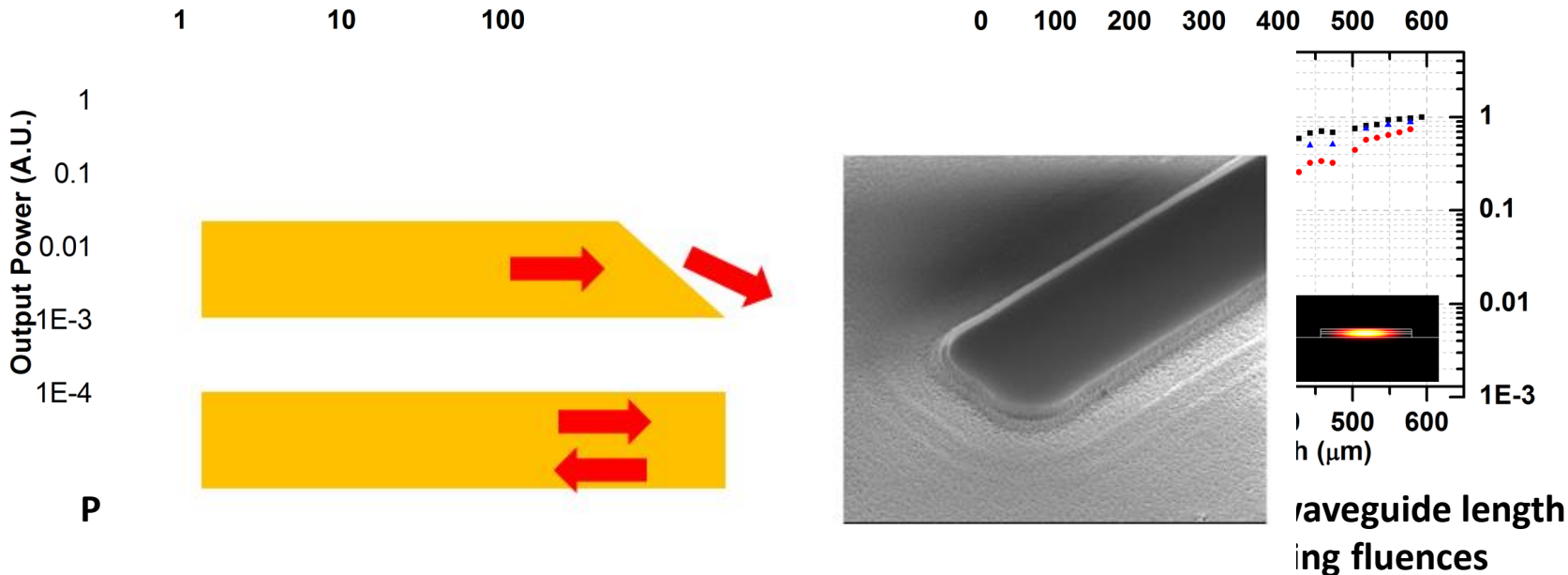

$$I = A_0 \frac{e^{gL} - 1}{g}$$



$$I = A_0 \left[\frac{e^{gL} - 1}{g} + \frac{R}{g} e^{2gL} (1 - e^{-gL}) \right]$$



212 cm⁻¹ @ 56 μJ/cm²
 206 cm⁻¹ @ 34 μJ/cm²
 169 cm⁻¹ @ 30 μJ/cm²

R=5%

No R

With R

COLLOIDAL QUANTUM DOTS AS GAIN MATERIAL

- Laser cavity design
 - 75 nm/50 nm/90 nm
SiN/CQD/SiN layer stack
with 35 nm depth grating

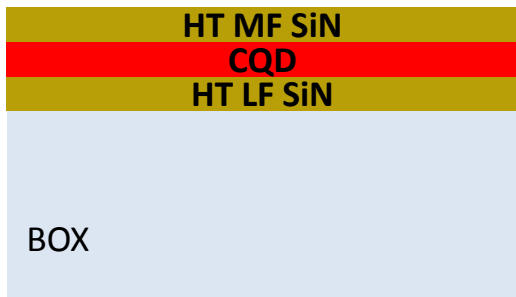

The simulated stop band of the grating. The ASE spectrum has been inserted.

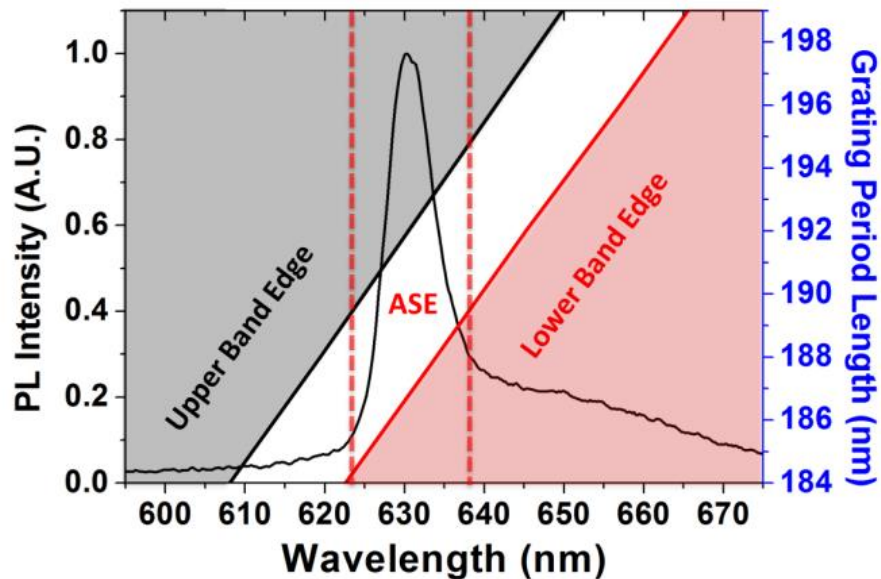

COLLOIDAL QUANTUM DOTS AS GAIN MATERIAL

- Laser cavity design

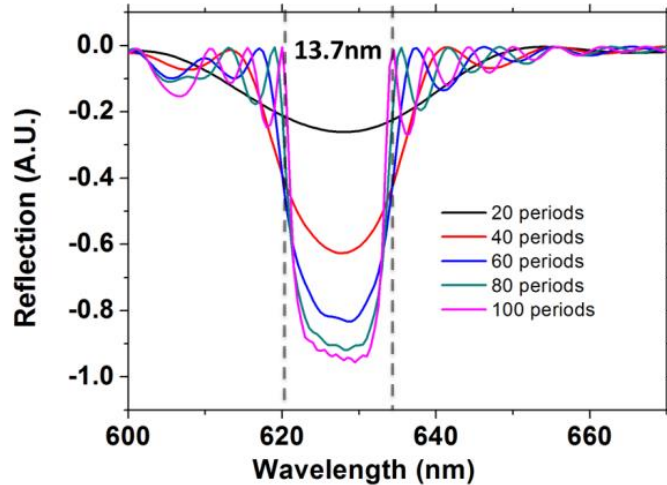

The reflection spectrum with different number of periods. The grating period is 188 nm.

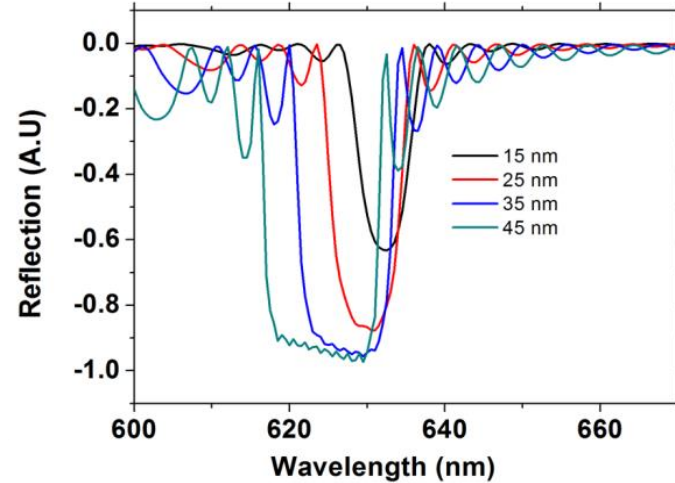

The reflection spectrum with different etching depth. The period is 188 nm and the number of periods is 100.

COLLOIDAL QUANTUM DOTS AS GAIN MATERIAL

- DFB laser fabrication process

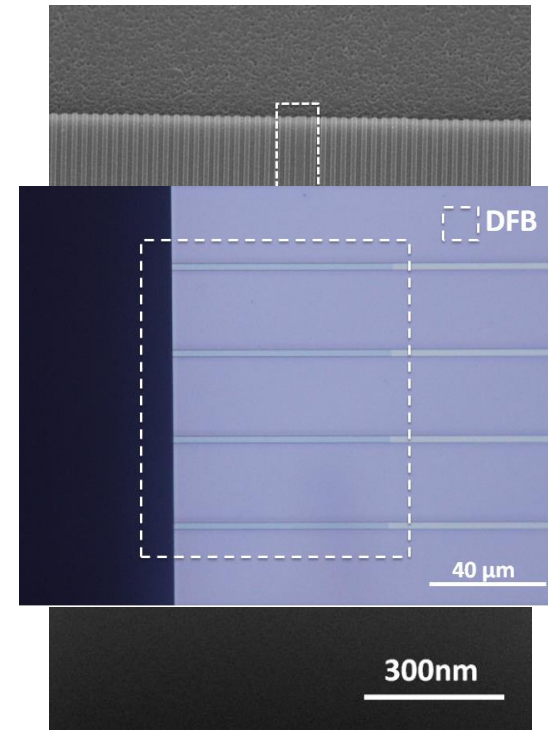
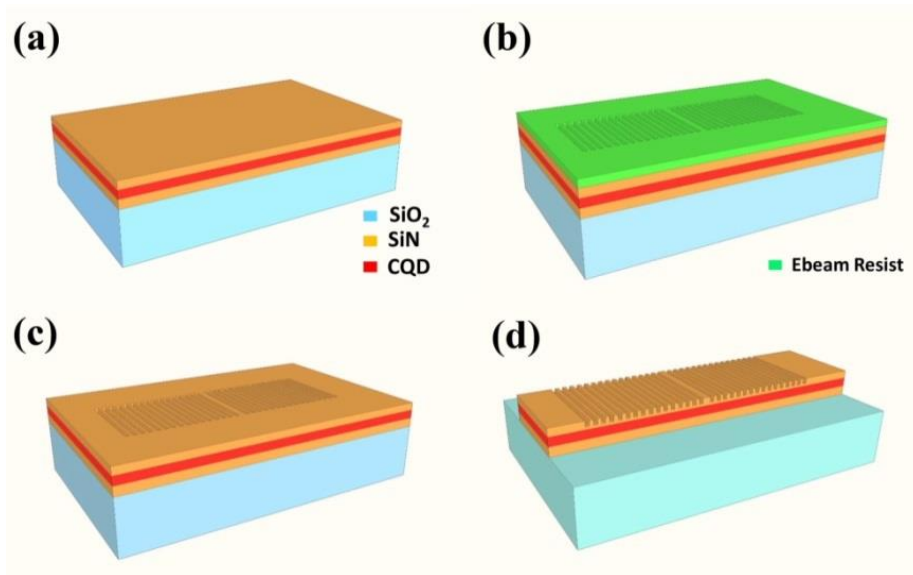

COLLOIDAL QUANTUM DOTS AS GAIN MATERIAL

- DFB laser characterization with fs laser pump

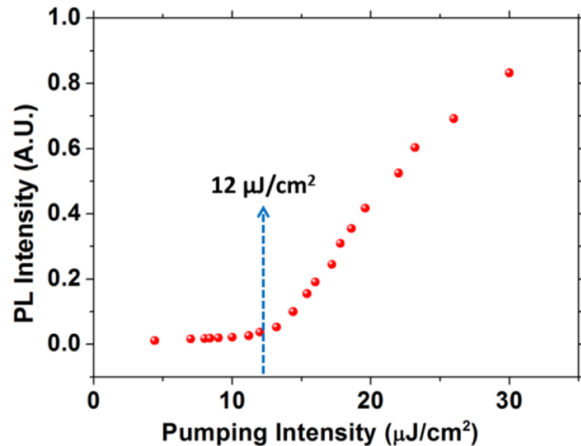

Light (in)-light (out) measurement on double linear scale for DFB laser with 188nm period.

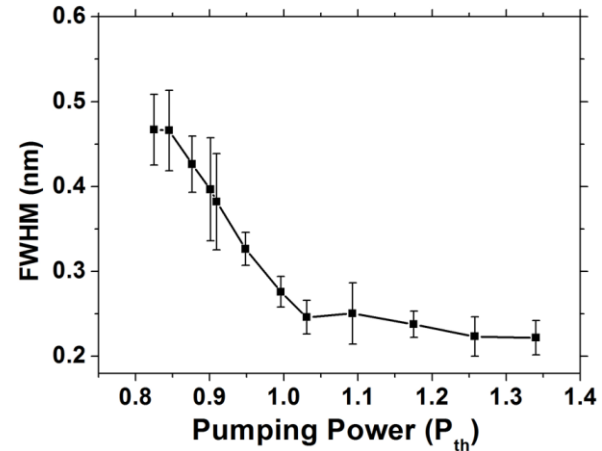

The evolution of the spectral width (FWHM) under the different pump intensity.

COLLOIDAL QUANTUM DOTS AS GAIN MATERIAL

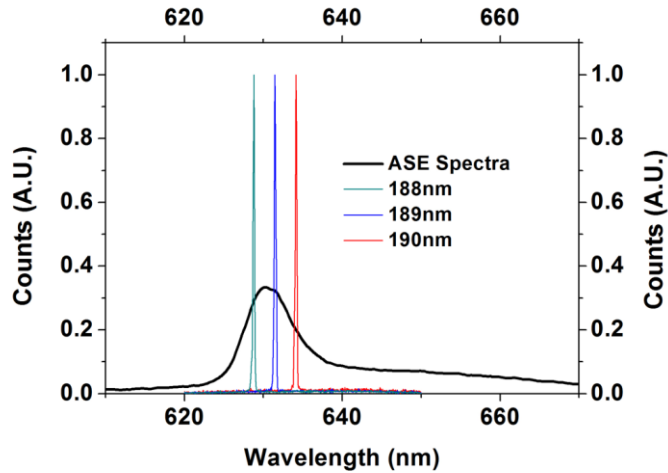

Spectra measured from an unpatterned waveguide (black) and DFB lasers with different grating periods (colored).

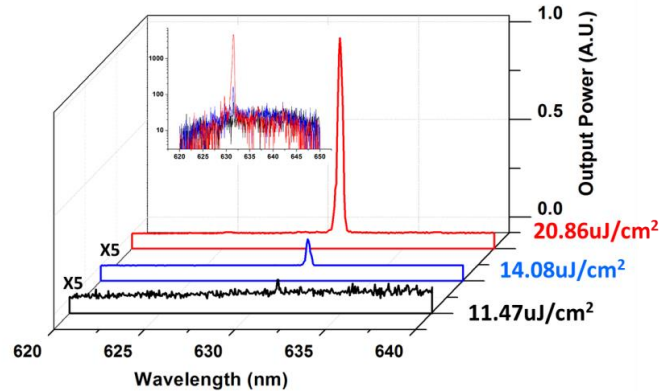

Spectra measured from laser with 188 nm period at different pump fluence. The inset is the log-scale measured spectra under different pump fluence

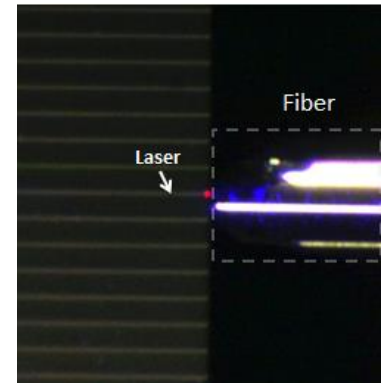
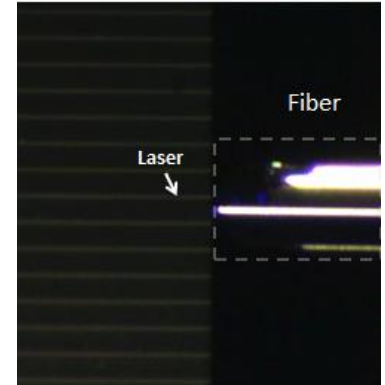

COLLOIDAL QUANTUM DOTS AS GAIN MATERIAL

- DFB laser characterization with ns laser pump

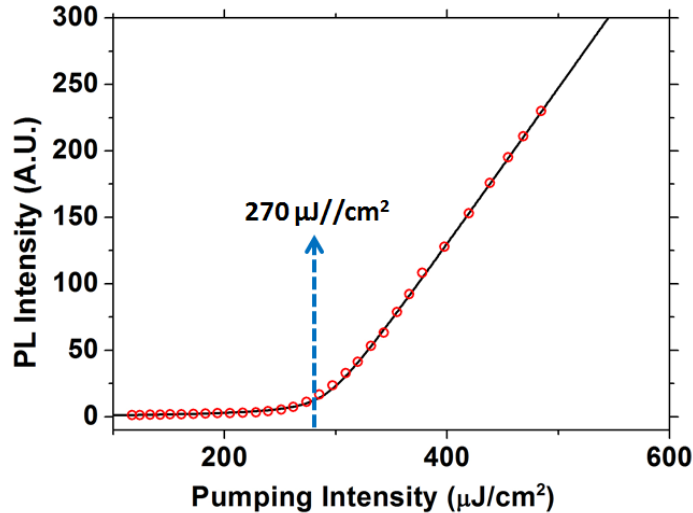

The lasing threshold around 270 $\mu\text{J}/\text{cm}^2$, which has an equivalent CW power density of 39 kW/cm^2 .

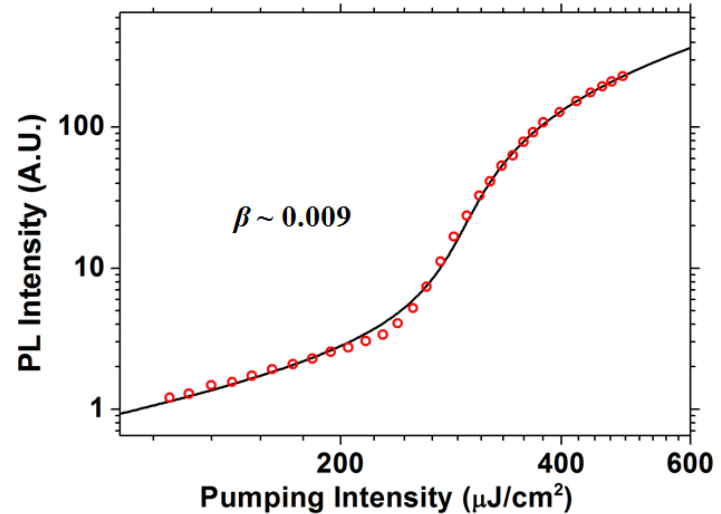

A spontaneous emission factor (β) 0.009 is extracted.

COLLOIDAL QUANTUM DOTS AS GAIN MATERIAL

- Gain-coupled DFB laser

- Coupling coefficient κ :
describes the amount of power transferred between the two contra-directional waves
 - Index-coupling: the refractive index varies periodically and κ is real
 - Gain-coupling : the gain varies periodically and κ is imaginary
- The gain-coupled optical feedback laser works better than index-coupled feedback laser
 - Stable in a single longitudinal mode
 - Immune to facet reflection (no need AR-coating)
 - Eliminate the spatial hole burning

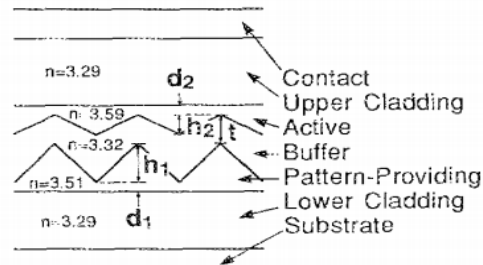

Etching will introduce defects for III-V grating patterning

Luo, Y. *et al.* Applied Physics Letters 56, no. 17 (1990): 1620-1622.

COLLOIDAL QUANTUM DOTS AS GAIN MATERIAL

- Colloidal QDs patterning with Ebeam
 - No etching is involved
 - Periodically patterning

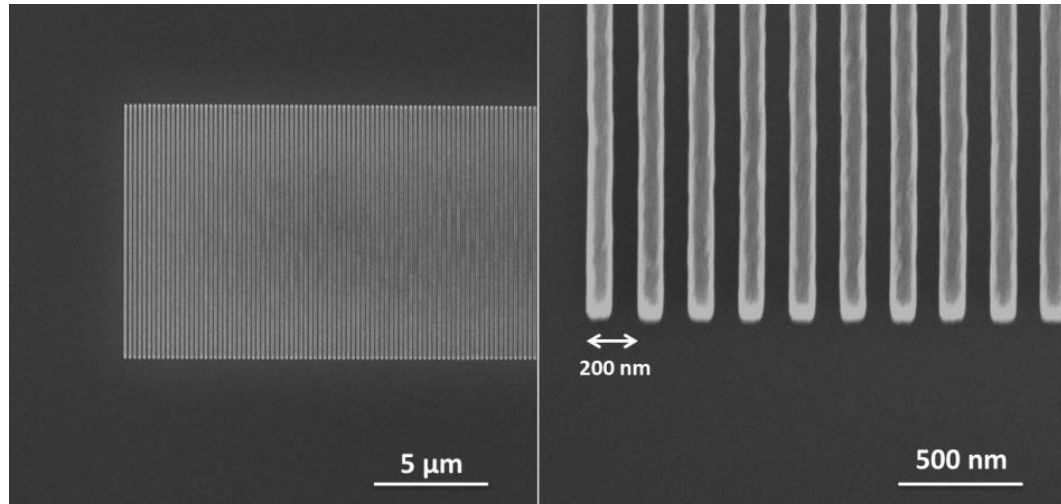

Left: the overall of the patterned grating. Right: the detail check of the patterned grating.

COLLOIDAL QUANTUM DOTS AS GAIN MATERIAL

- Fabrication process

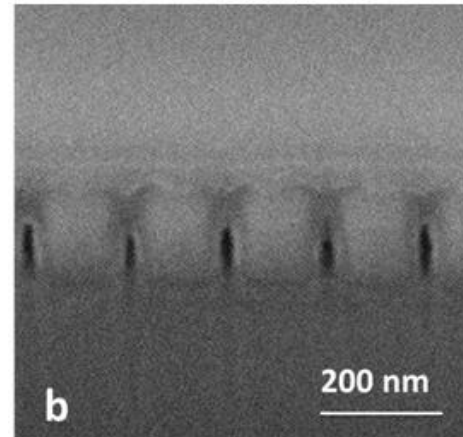
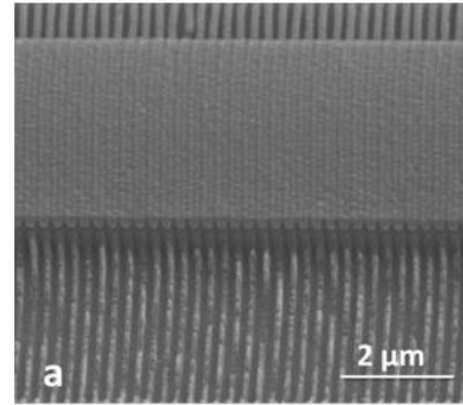
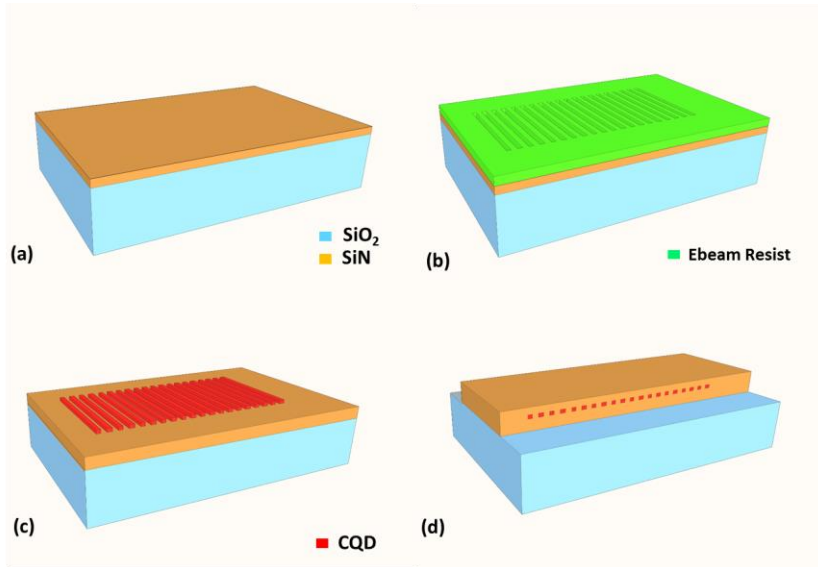

COLLOIDAL QUANTUM DOTS AS GAIN MATERIAL

- Gain-coupled DFB laser characterization with ns laser pump

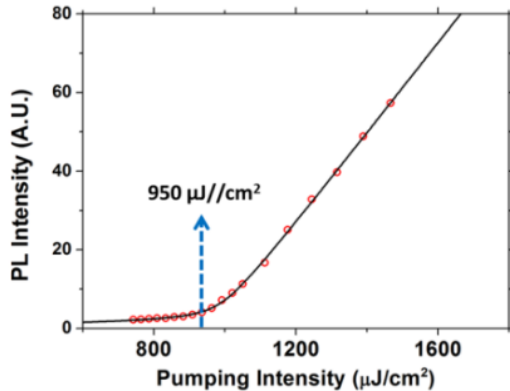

The lasing threshold is around 950 $\mu\text{J}/\text{cm}^2$, which has an equivalent CW power density of 135.7 kW/cm^2 .

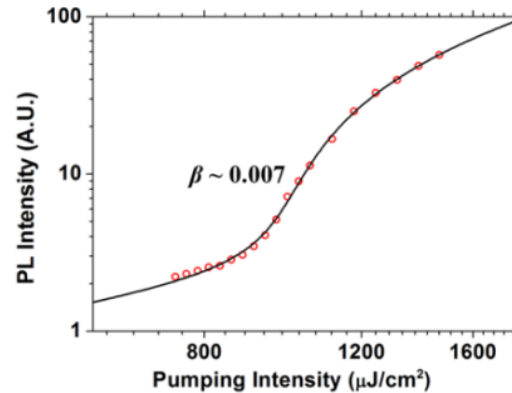

A spontaneous emission factor (β) 0.007 is extracted.

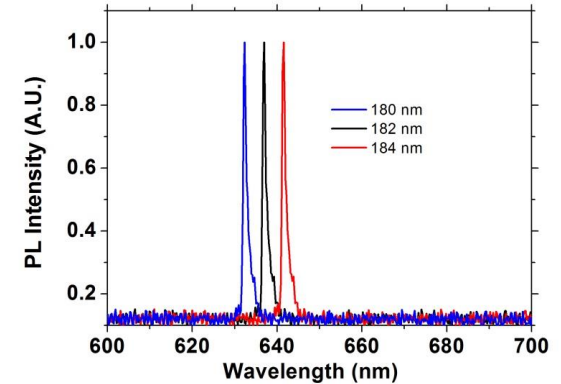

Emission spectra of three devices with a varying grating period (pump fluence = 1100 $\mu\text{J}/\text{cm}^2$ @ 532 nm).

COLLOIDAL QUANTUM DOTS AS GAIN MATERIAL

- Colloidal nano-platelets integration

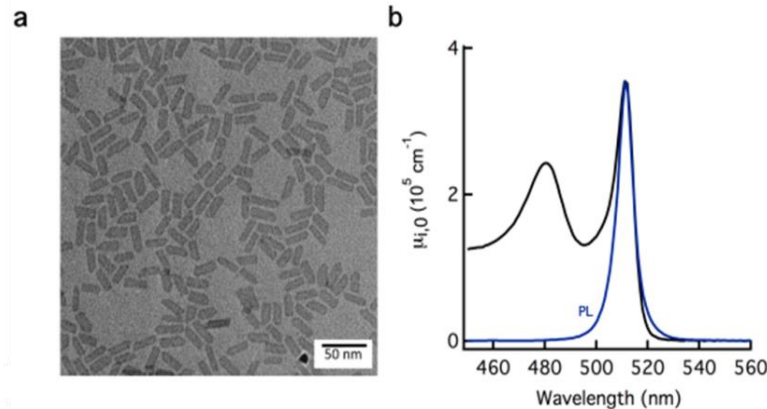

(a) Transmission Electron Microscope (TEM) image of 4 monolayers thick CdSe nano-platelets with an average lateral area of 34 by 9.6 nm². (b) Photoluminescence (blue) linear absorption spectrum (black) of CdSe NPLs dispersed in hexane, normalized to represent the intrinsic absorption coefficient.

COLLOIDAL QUANTUM DOTS AS GAIN MATERIAL

- Colloidal nano-platelets integration fabrication

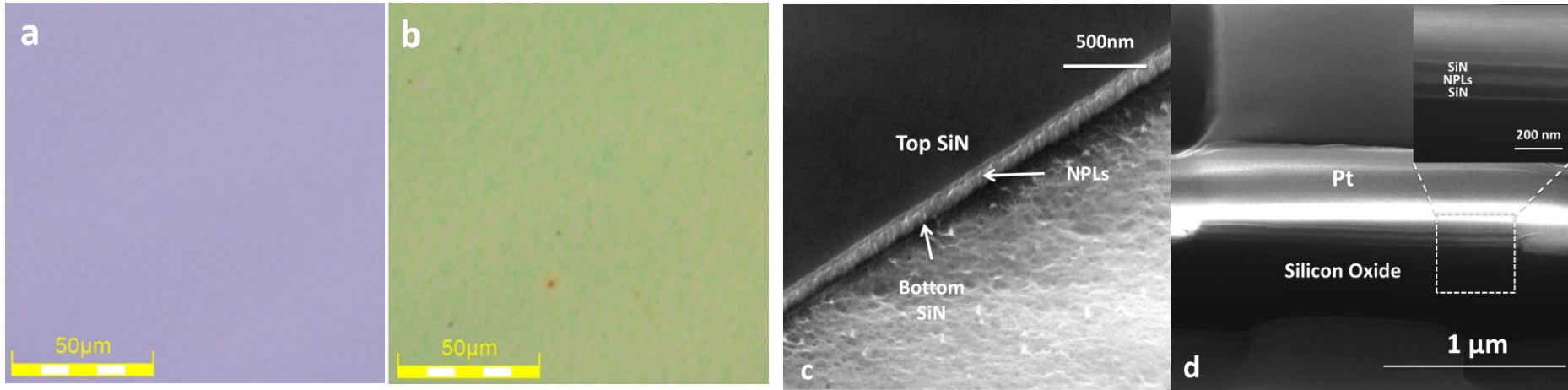

The microscopy picture comparison

SEM picture of the fabricated sample.

COLLOIDAL QUANTUM DOTS AS GAIN MATERIAL

- Colloidal nano-platelets WG gain measurement

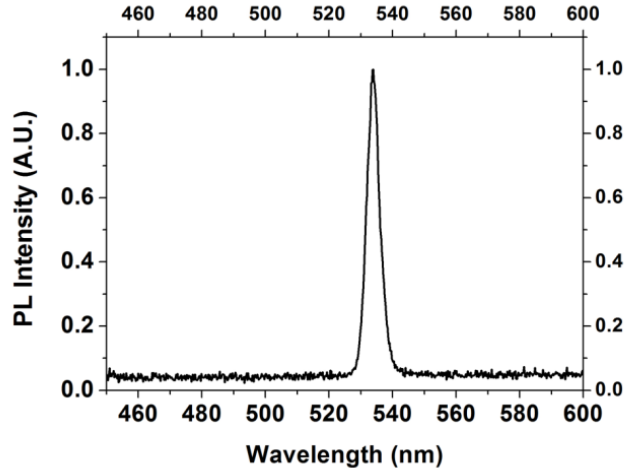

Emission spectrum of a 4 μm wide
100 μm long waveguide with
pumpfluence 440 $\mu\text{J}/\text{cm}^2$ @ 400 nm

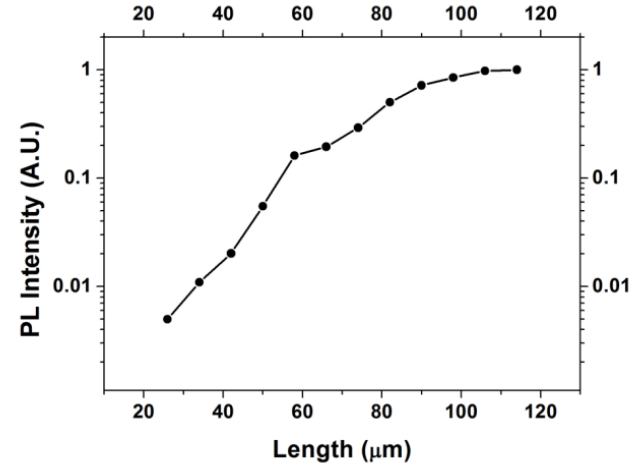

The measured material gain is about
3500 cm^{-1} .

OUTLINE

- Motivation
- Colloidal quantum dots as light emitting material
- SiN waveguide platform optimization
- Colloidal quantum dots as gain material
- Colloidal quantum dots as single photon emitter
- Conclusion

COLLOIDAL QUANTUM DOTS AS SINGLE PHOTON EMITTER

- Colloidal QDs' single photon emission

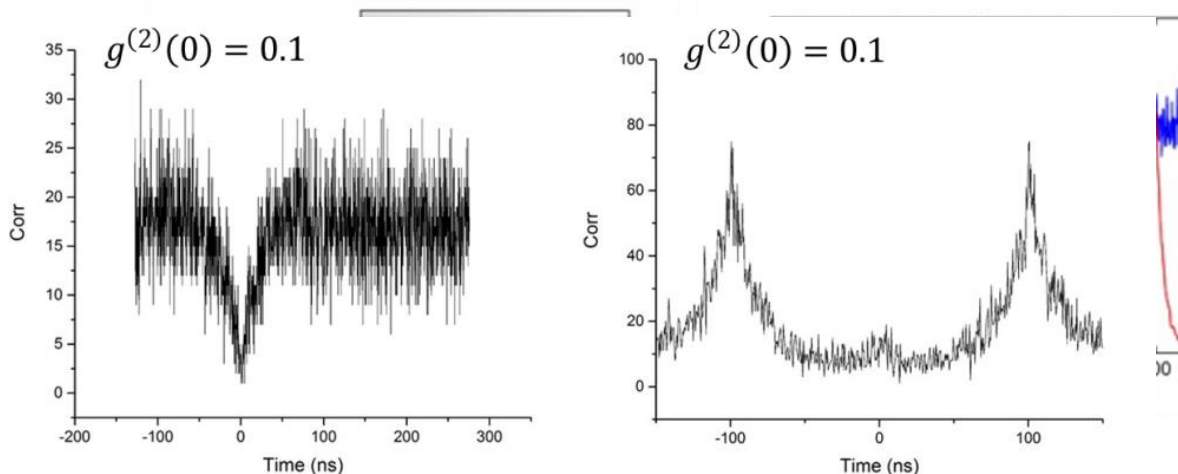

V. Chandrasekaran, *et al.* Proceedings Symposium IEEE Photonics Society Benelux, 2016

measurement results of a single photon source by using the Hanbury Brown-Twiss interferometer set-up. The blue curve is the result with CW excitation, the red curve is the result with pulsed excitation.

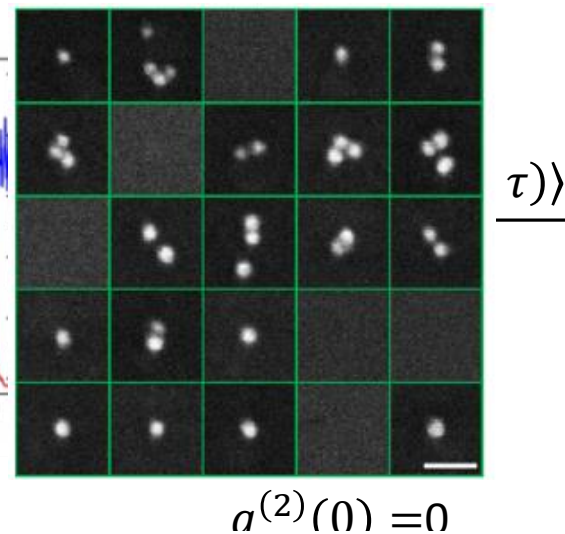

W. Xie *et al.* Nano letters 15, no. 11 (2015): 7481-7487.

FOR IDEAL SINGLE PHOTON SOURCE

COLLOIDAL QUANTUM DOTS AS SINGLE PHOTON EMITTER

- Motivation to design a compact grating coupler

We would like to combine these dots with our SiN waveguide platform.

A compact grating coupler is need to

- Efficiently couple light from waveguide to a microscopy system
- Small foot print to fit the field-of-view for high NA microscopy system

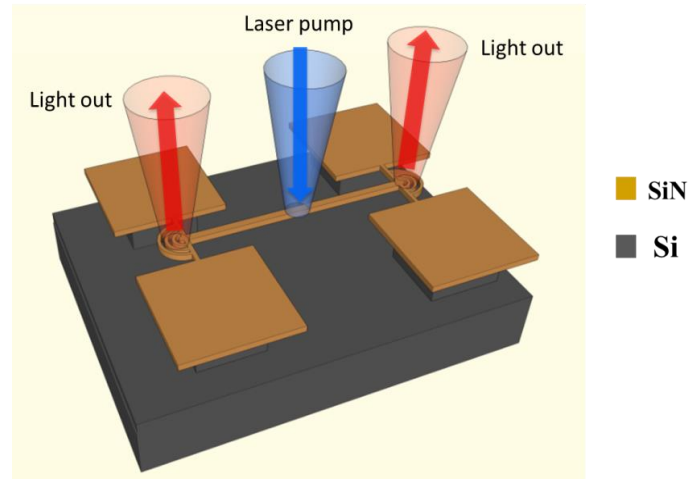

COLLOIDAL QUANTUM DOTS AS SINGLE PHOTON EMITTER

- Grating coupler design

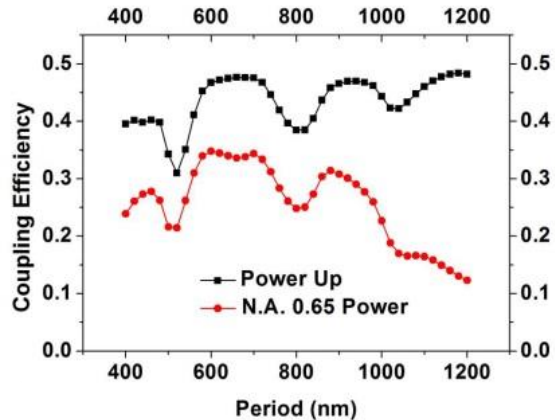

period length vs power up/power collected with NA = 0.65;

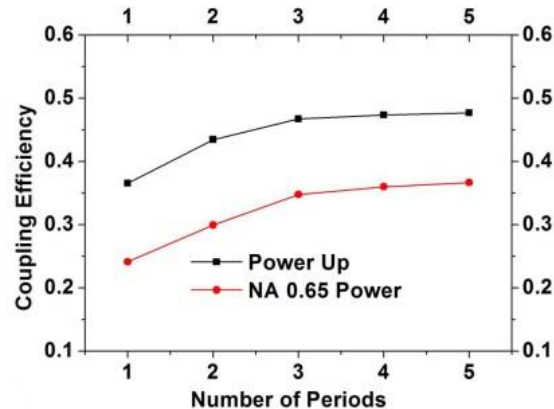

number of periods vs power up/power collected NA = 0.65

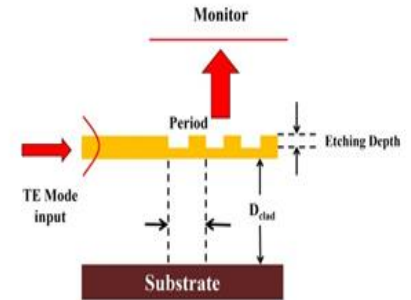

COLLOIDAL QUANTUM DOTS AS SINGLE PHOTON EMITTER

- Grating coupler design

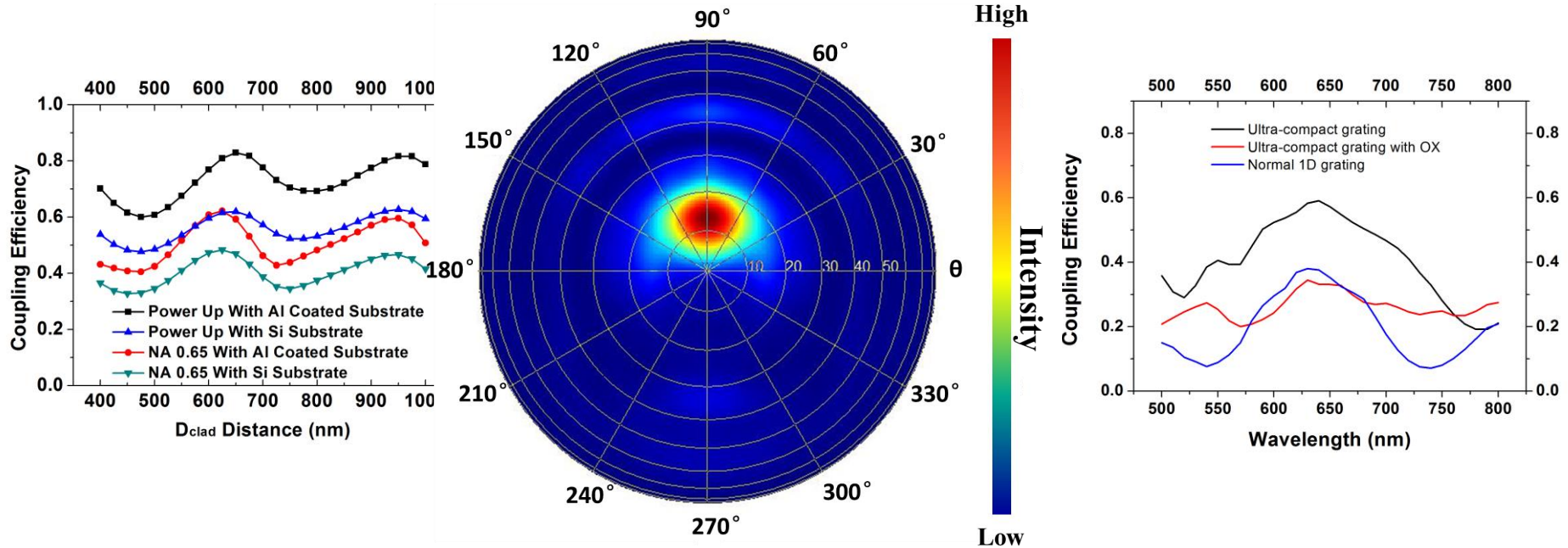

COLLOIDAL QUANTUM DOTS AS SINGLE PHOTON EMITTER

- Ultra-compact SiN grating coupler for microscopy system

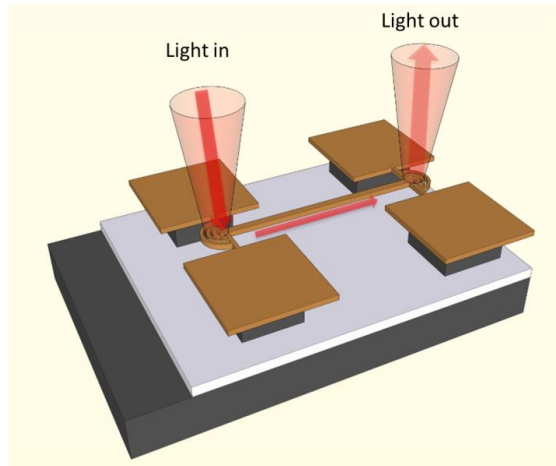

Fabrication Flow

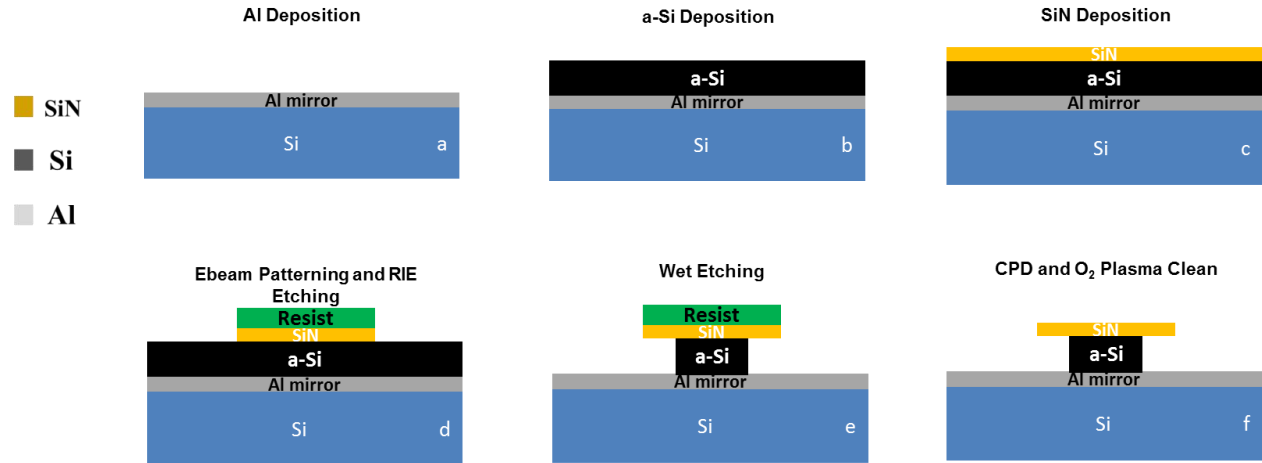

COLLOIDAL QUANTUM DOTS AS SINGLE PHOTON EMITTER

- SiN layer with different stress

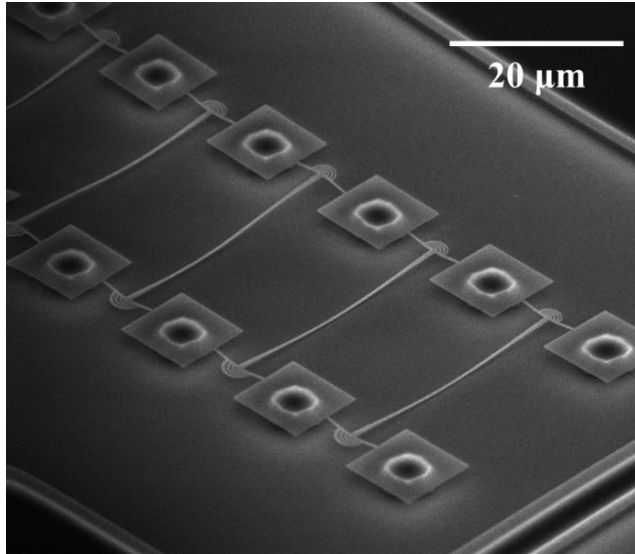

Compressive stress

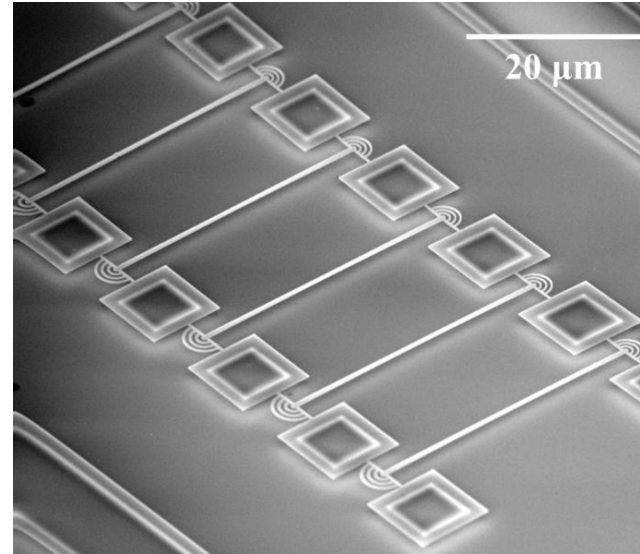

Tensile stress

COLLOIDAL QUANTUM DOTS AS SINGLE PHOTON EMITTER

- Characterization

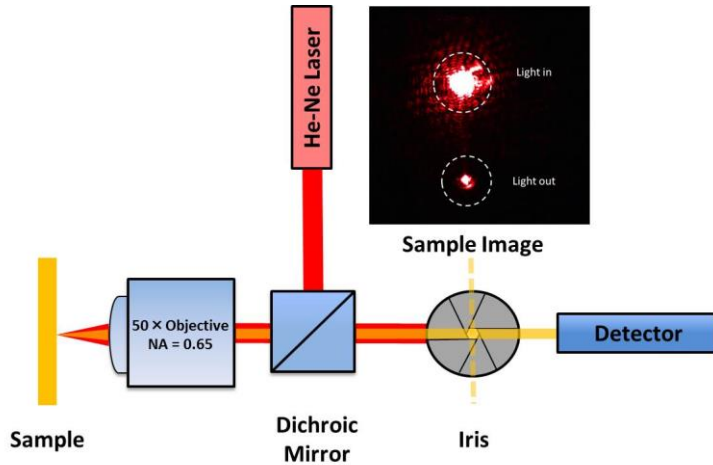

Microscopy system setup for the measurement

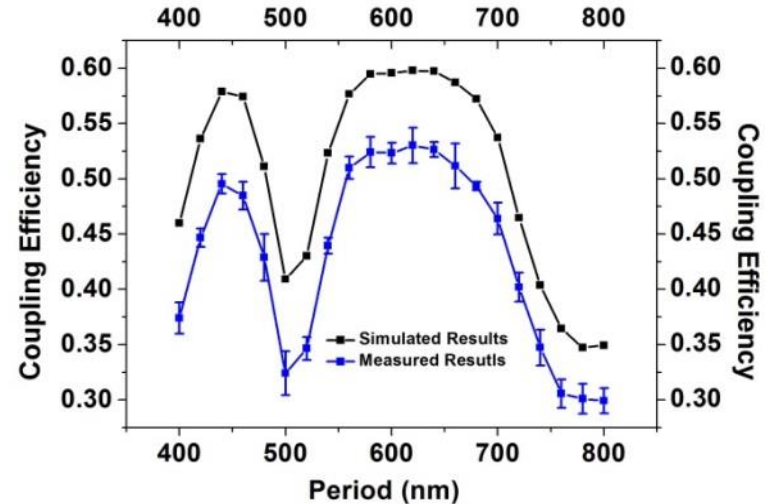

Measurement results: the black curve is the simulated power couple to a microscopy system with NA=0.65; the blue curve is the measured results with a 950 nm distance between the grating coupler and the Al substrate.

COLLOIDAL QUANTUM DOTS AS SINGLE PHOTON EMITTER

- WG with embedded monolayer QDs

Fabrication Flow

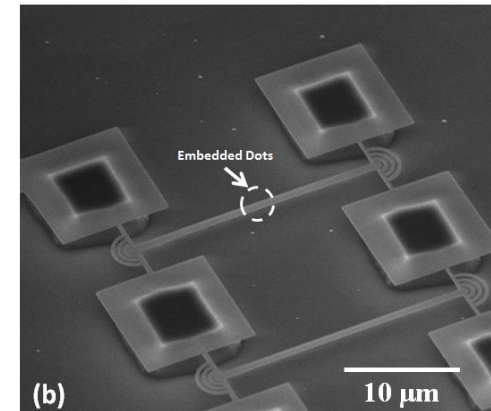
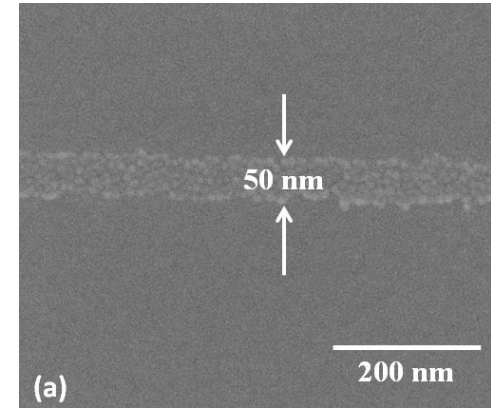
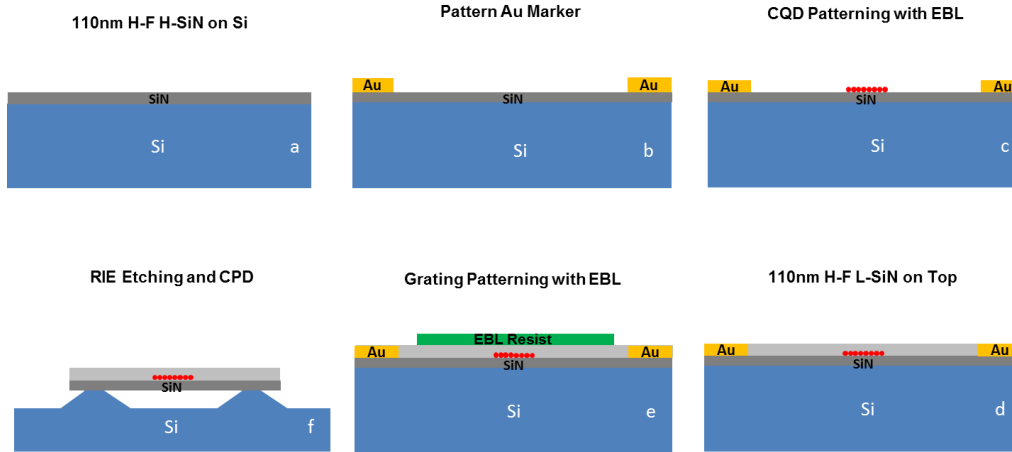

COLLOIDAL QUANTUM DOTS AS SINGLE PHOTON EMITTER

- Characterization

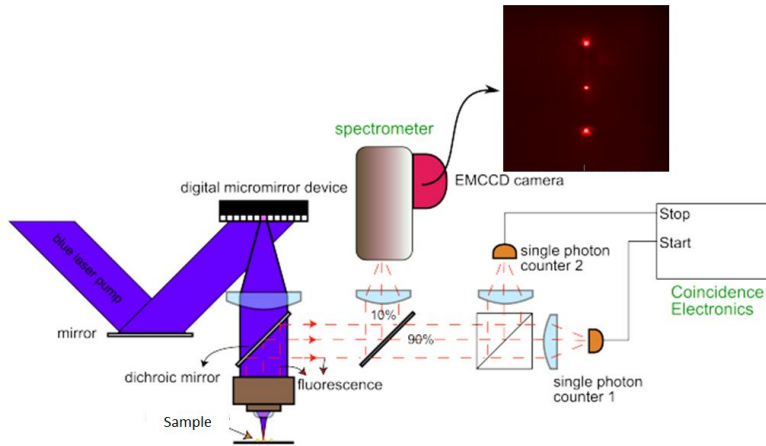

The schematic of the micro-photoluminescence setup diagram

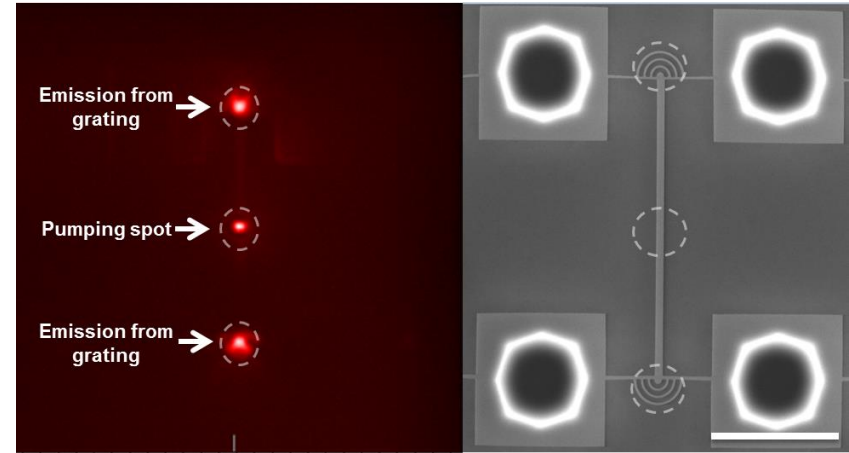

The captured image with the EMCCD camera. A top view SEM image of the device structure is also shown on the right as a compare. The scale bar is 10 μm .

COLLOIDAL QUANTUM DOTS AS SINGLE PHOTON EMITTER

- Future work

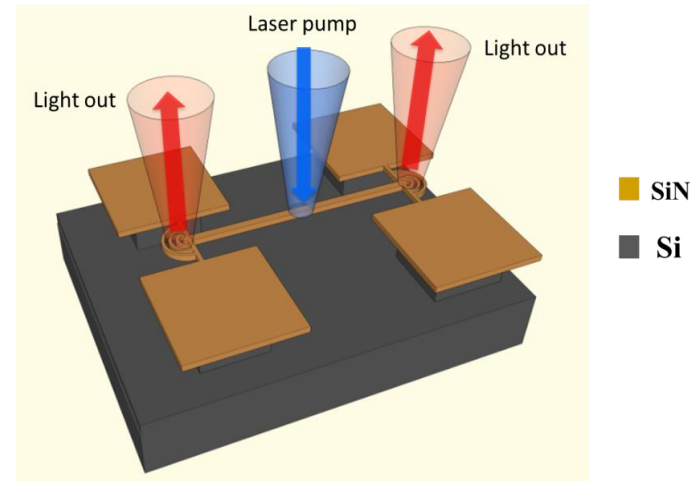
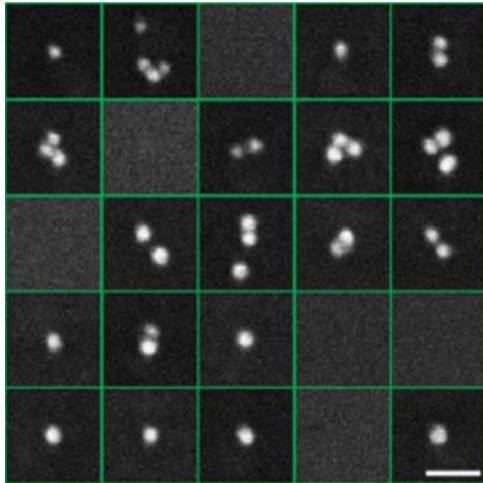

To combine the single dot patterning technique with the waveguide and the grating coupler to demonstrate a on-chip single photon source.

CONCLUSION

- A low-loss hybrid SiN colloidal QDs integration platform
 - Low loss SiN waveguide
 - Low loss SiN waveguide with embedded colloidal QDs
 - The emission of the colloidal QDs have been preserved
- Integrated laser with colloidal QDs
 - WG based gain coefficient measurement
 - Fs laser pump lasing
 - Ns laser pump lasing
 - Gain-coupled lasing
 - The platform can be used for other nanocrystal integration
- Potential on-chip single photon emitter
 - Ultra-compact grating for microscopy system
 - Monolayer colloidal QDs integrated with waveguide and grating

Thanks. Questions?

CW PUMPING

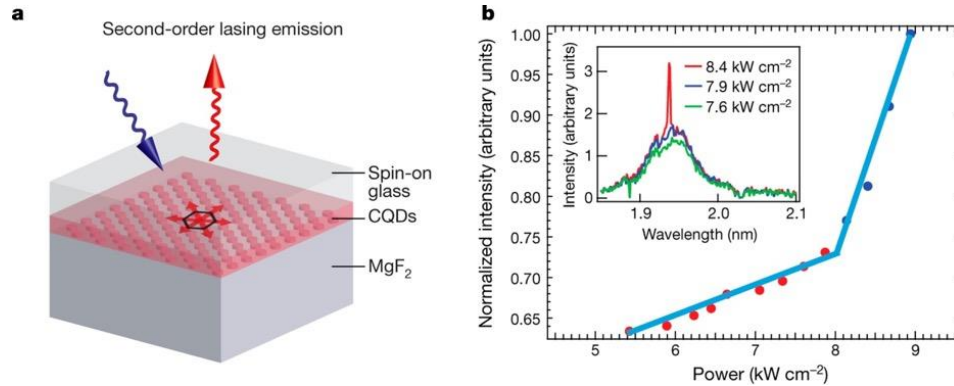

Sargent Group: CW lasing demonstrated

F Fan, *et al. Nature* 1–5 (2017) doi:10.1038/nature21424

The key factor

- Improved heat management: heat sinking
- Improved pumping setup

ELECTRICAL PUMPING

- Recent results from Klimov group show electrical pumping is realistic

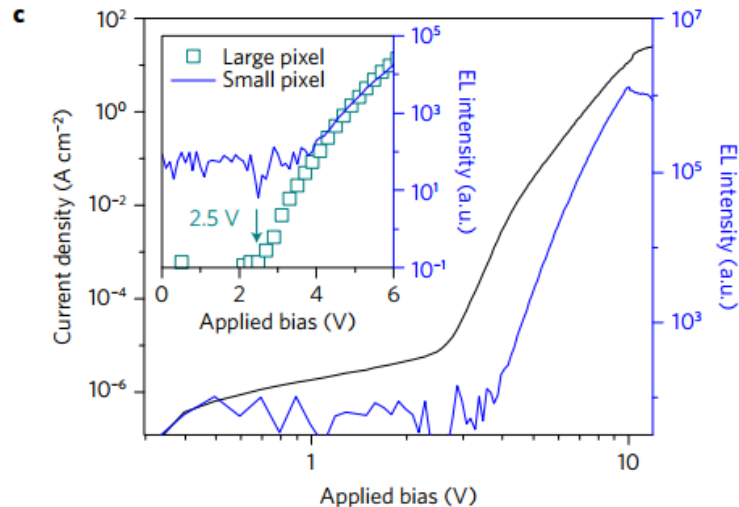
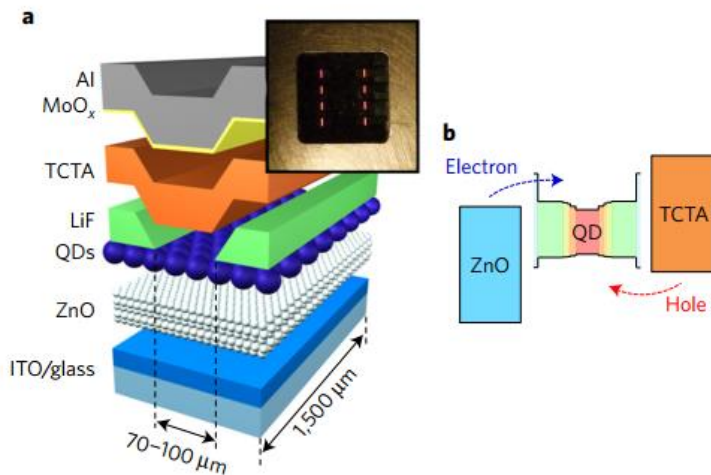

J. Lim *et al.*, Nature Materials, 2017